

Hunter®

 **Hydrawise™ Ready**
IRRIGATION CONTROLLERS

Hydrawise Software/App Owner's Manual



hydrawise.com

Table of Contents

Table of Contents	2
Controller - Reboot Controller	4
Controller - Navigating Screens	5
Wireless - Connection Status Messages	6
Controller - Viewing Controller Status	7
Server Status	8
Success	9
Offline	10
Saving Settings	11
Serial Number	11
Controller - Viewing Network Information / Testing Internet Connectivity	11
Controller - Viewing Time and Date	12
Controller - Installing and Wiring	13
Controller - Function Paths	13
Controller - Manual Operation	15
Running a zone manually from the controller	16
Controller - Factory Default	17
Controller - Serial Number Location	18
Controller - Blank Display	20
No Zones Running	21
Test Water Supply	21
Test Controller Voltage	22
Test Wi-Fi on the Controller	23
Sprinklers Running with the Controller Off or Unplugged	24
Account - Resetting Password	25
Account - Not Receiving Hydrowise Activation Emails	27
Account - API Information	28
Smart Voice Device - Amazon Alexa	28
Home Automation - Control4	32
Account - Translation Options	33
iOS and Android App Support Policy	35
Offline Programming - Standard	36
Offline Mode - Accessing Offline Mode	38
Offline Mode - Run the Setup Wizard	40
Offline Adjustments - Watering with no Internet	43
Offline Mode - Sensors	43
Offline Mode - Turning Off Start Times	45
Offline Mode - Seasonal Adjust	47
HPC - Upgrading Pro-C	49
HPC/HCC - Using Hunter Remotes	50
Wiring	51
Operation	52
HCC - Valve Wiring	52
HCC - AC Wiring	53
HCC - Two Zones Simultaneously	57

Lightning Transformers with Controllers	58
HPC- WRCLIK and HC Flow Meter	59
Flow Meter Pressure Loss Chart	61
Flow Meter - Configuration	61
Flow Meter - Quick Start Guide	64
Flow Meter - Installation Tips	64
Flow Meter - Specifications	66
Flow Meter - Reading Meter	67
Flow Meter - Testing Meter	69
Flow Meter - Custom Flow Sensor Configuration	70
Single Flow Meter - Sharing Two Controllers	72
Flow Meter - Winterization	73
Pump Start Relay Wiring and Online Setup	75
Summary	75
Operation Chart	75
Wiring (24 VAC)	75
Wiring to Power Source	77
Online Setup	78
Pump Start Relay Operation per Station	79
Master Valve Wiring and Online Setup	80
Brief Summary	80
Operation Chart	80
Wiring	81
Setup Online	82
Master Valve (P/MV) Operation per Station	83
Valve - Wire Distance	84

Controller - Reboot Controller

Please follow the steps below to perform a reboot on your controller. This can help reestablish WiFi if you are having communication issues. The reboot will not erase any settings in your controller.

1. From the home screen, tap on **Settings**.
2. Next, press **Config**.
3. Press **Reboot Controller**.

STEP 1



STEP 2

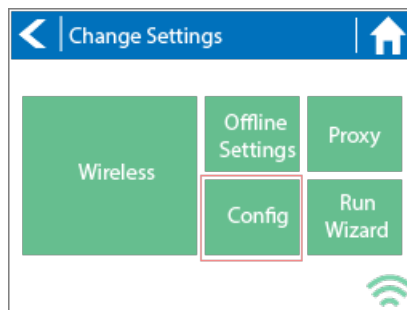

STEP 3

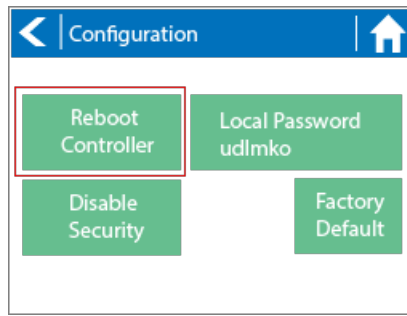

Controller - Navigating Screens

The controller features a full color touchscreen making navigation easy.

The Home screen, shown below, has 3 buttons allowing you to view and run your irrigation zones, change controller settings or view status information.



- 1 Touch to view all zones
- 2 Touch to change controller settings
- 3 Touch to view controller status information

Each screen (except for the home screen) has two buttons at the top of the page allow you to quickly navigate to the Home screen or the previous screen.



- 1 Go to previous screen (changes not saved)
- 2 Go to Home screen (changes not saved)
- 3 GREEN items indicate settings which can be changed
- 4 GREY items indicate status information

All items on each screen are color coded to indicate which screen elements are buttons and which screen elements indicate status information.

GREEN screen items indicate settings that can be changed. If you touch on the GREEN color item then you'll be able to change that setting.

GREY colored items indicate status information. Touching on these has no effect.

If you're entering information into the controller and use the Home or Back buttons then your changes on that screen will not be changed.

Wireless - Connection Status Messages

The controller will show different status messages while connecting to your wireless router.

Looking for Wireless	Controller is currently scanning for local wireless networks.
Connecting to	Controller is currently trying to connect to your wireless router.
Waiting for IP	Controller has connected to your wireless router and is waiting for your wireless router to give it an IP address. Your wireless router must be configured as a DHCP server.
Connected	Controller has successfully connected to your wireless router.
Local Connection Only	Controller is acting as a local wireless router.

Troubleshooting Wireless Connection Issues

After entering your wireless settings, the controller will connect to your access point. The connection process takes about 30 seconds.

Upon successful connection the wireless status will show **Connected**.

If your controller fails to connect to your wireless router check the following:

- Your password is entered It is case sensitive and must be at least 8 characters long.
- Check that the wireless security types match between the controller and your wireless router. Hydrowise recommends use of WPA2 security between the controller and your wireless router.
- We have WiFi specifications here: [WiFi Specs](#) ^[1]

Controller - Viewing Controller Status

From the Home screen, navigate to the Controller Status by pressing Status > Controller Status.

The controller status screen shows your controller's connection to Hydrowise servers for synchronizing schedule and weather information.

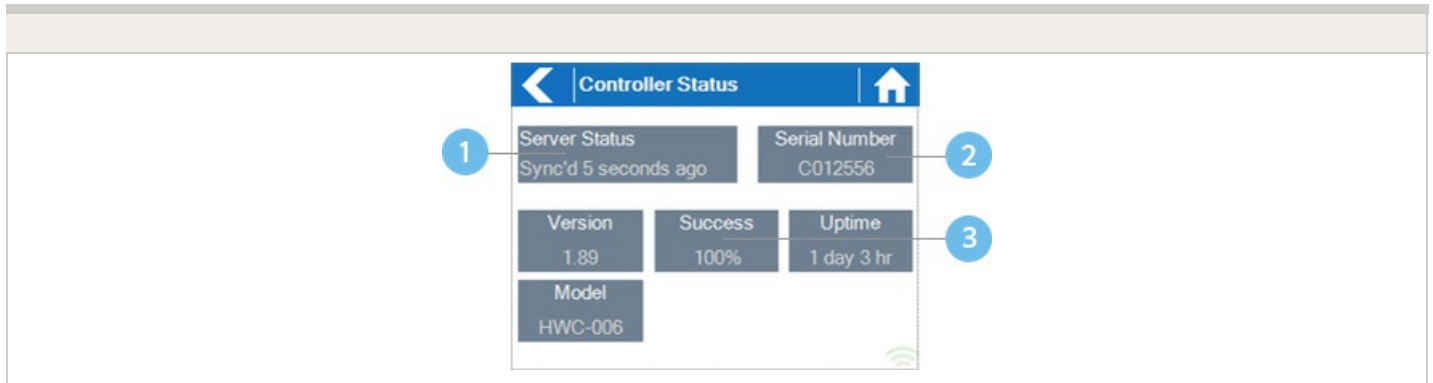

- 1 Status of Connection to Hydrowise Servers
- 2 Your Serial Number. Used to link your controller to your account
- 3 Connection to Hydrowise Success Rate

Server Status

A successful connection to the Hydrowise servers is indicated by **Sync'd** as the Server Status.

SERVER STATUS MESSAGES

Message	Description
OK - updated xxx seconds ago	The controller is connected to Hydrowise and last got a configuration update xxx seconds ago. This is the normal state.
Wireless Down	Wireless is not connected
OK - Updating certificates	The controller is doing an initial upgrade from version 2.x to 3.x software. You should only see this once, if the controller is continually showing this then there is a problem - please contact Anthony with a video of the problem.

OK - Downloading Software	The controller is doing a firmware upgrade. During this period no configuration changes will be processed by the controller.
Connecting in xxx seconds	The controller is not connected and is waiting xxx seconds before attempting to reconnect to the internet. When a connection fails we do not try to reconnect immediately - there is an escalating delay between 5 seconds the 60 minutes (worst case after 33 unsuccessful connections). There is a “Reconnect Now” button on the Controller Status screen to force a reconnection immediately if you’re in front of the controller.
Connecting to the Internet	The controller is attempting to connect to the internet
Connecting to Hydrawise	Controller has connected to the internet and is now connecting to the Hydrawise servers
OK - subscribing to updates	Controller has connected to Hydrawise and is getting its configuration
OK - processing cloud update	Controller is connected to Hydrawise and is processing a configuration change
Updating Wi-Fi firmware	The controller is updating the Wi-Fi firmware to 19.5.4. During this period no configuration changes will be processed by the controller.
Updating Pro-C adapter	The controller is updating the Pro-C adapter software. During this period no configuration changes will be processed by the controller.

Success

Success percentage - this is the percentage of time the controller has been connected to Hydrowise. We measure this over a 6-hour time frame. 100% means it was always connected, 80% means that for 20% of the time it was not connected.

A low success percentage will indicate a poor wireless connection between the controller and your access point.

To improve your wireless signal strength you could try the following –

- Move the controller closer to your wireless router.
- Remove any obstacles in a direct line of sight between the controller and your wireless router such as metal items (metal is an extremely good isolator for WiFi signals).
- Move your wireless router closer to the controller.
- Install a higher gain antenna on your wireless router.
- Use Ethernet to a location closer to the controller and install a new wireless router.
- Consider a WiFi repeater/extender between your wireless router and the Hydrowise controller to boost the signal strength.
- Consider moving the controller away from potential sources of interference, including microwave ovens, nearby base stations using adjacent channels or cordless telephones operating in the 2.4GHz range (you could also change the channel your phone uses).

Note that the Hydrowise unit is designed to work in poor wireless environments. However, if you wish to manually run or stop a zone and the wireless signal is down then these actions will fail.

Offline

If the controller loses internet for more than 24 hours you'll receive a notification email.

The controller will go into an offline mode. In offline mode, your controller won't be able to access local weather conditions such as rainfall or evaporation and will revert to a pre-defined program.

- For Smart Watering zones, the controller will adjust each zone's watering length based on your offline watering budget and will water at each zone's configured peak watering frequency.
- For Time Based Watering zones, the controller will adjust each zone's watering length based on your offline watering budget and will water at each zone's configured watering frequency.
- For more information on Smart and Time Based Watering, see "[Configuring Irrigation Zones](#)" ^[2].
- Note that Cycle & Soak is not supported in Offline Mode and each zone will water for its full watering length without pausing.

- The controller will only water at your configured Program Start Times.

Saving Settings

The controller does not need a battery, all settings are saved in a non-volatile RAM (memory).

Serial Number

The serial number is used to link your actual controller with your Hydrowise account. This number is also printed on the rear of the controller.

Controller - Viewing Network Information / Testing Internet Connectivity

From the Home screen navigate to the Network Status by pressing Status > Network Status.

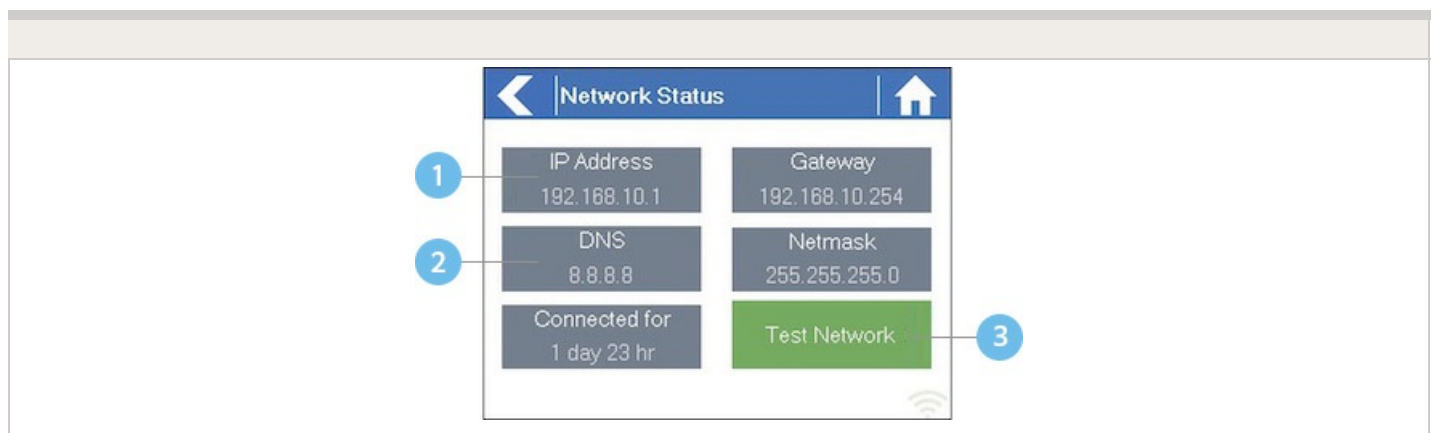

- 1 IP Address (set by your wireless router)

2 DNS Address (set by your wireless router)

3 Network Test Button

All settings on this page are provided to the controller by your wireless router when it first connects via a protocol, known as DHCP. If any of these settings appear incorrect please change them in your wireless router.

Once the controller has successfully connected to your wireless router the Test Network button can be used to test network connectivity for troubleshooting purposes. The network test will verify connectivity to 4 destinations –

Test Network

Message Description **Checking WiFi** Performs a ping test to the Gateway address listed in the Network Status screen. If this test fails, check that you don't have MAC address filtering enabled on your router. **Checking DNS** Performs a ping test to the DNS address listed in the Network Status screen. If this test fails, check that the DNS address is correct – if it is wrong then correct the DNS address under DHCP Settings on your wireless router. It is possible that this test may fail if the DNS server doesn't accept ping requests which do not indicate an issue. **Checking Internet** Performs a ping test to the Google server at IP address 8.8.8.8. This is a well-known server which accepts ping requests on the internet. If this test fails then it indicates an issue with the internet configuration of your wireless router. **Checking Hydrowse** Performs a ping test to the Hydrowse servers. If this test fails then it may indicate an issue with the internet configuration of your wireless router.

Controller - Viewing Time and Date

Time and date settings are synchronized with the settings that you configure in the Hydrowse app. The timezone is set based on the location you entered during the app wizard.

Time and Date

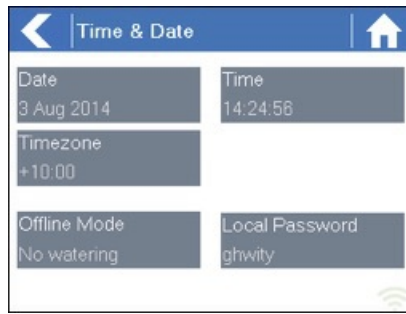

If your controller is running as a stand-alone controller (WiFi is disabled) then the date, time and time zone will be shown on a GREEN background can be changed.

Controller - Installing and Wiring

You can also find the instructions included with the controller on our [Quick start Guides](#) ^[3] page.

For instructions on installing your residential controller, please visit our basic wiring setup page for PROHC and HC models [here](#) ^[4].

NOTE: Once you've wired and installed your controller, please see [Configuring Your Controller](#) ^[5] for instructions on how to connect to your Wi-Fi.

Controller - Function Paths

Below is a list of function paths for use with the controller interface in both online mode and

offline mode.

ONLINE MODE

Change Wi-Fi/Check Status: Home>Settings>Wireless>Select a Setting to Modify

Controller Status: Home>Status>Controller Status

Program Expander: Home>Status>Expansion Modules

Manually Run Zone(s): Home>Zones>Select Zone> Run>Enter Time>OK

Model: Home>Status>Controller Status

Network Status: Home>Status>Network

Reboot Controller: Home>Settings>Config>Reboot Controller

Reset Controller: Home>Settings>Config>Factory Default

Run Wizard: Home>Settings>Run Wizard

Sensor Status: Home>Status>Sensor

Serial Number: Home>Status>Controller Status

Server Status: Home>Status>Controller Status

Test Network: Home>Status>Network>Test Network

Test Zone: Home>Status>Zone Tester

Time and Date: Home>Status>Time

Version Number: Home>Status>Controller Status

Zone Status: Home>Zones>Select Zone

OFFLINE MODE (Versions 3.33 and below)

Note: Changes can be done in offline mode only when Wi-Fi is disabled.

Adjust Time: Home>Settings>Offline Settings>Time

Disable Wi-Fi: Home>Settings>Offline Settings>Disable Wi-Fi

Program Expander/Check Status: Home>Settings>Offline Settings>Expansion Modules

Program Sensor/Check Status: Home>Settings>Offline Settings>Sensors

Program Start Times: Home>Settings>Offline Settings>Program Start Times

Set Seasonal Adjust: Home>Settings>Offline Settings>Seasonal Adjust

OFFLINE MODE (Version 4.01 Standard Mode)

Note: Changes can be done in offline status only when Wi-Fi is disabled.

Adjust Time: Home>Settings>Offline Programs and Settings>Time

Disable Wi-Fi: Home>Settings>Offline Programs and Settings>Disable Wi-Fi

Program Sensor/Check Status: Home>Settings>Offline Programs and Settings>Sensors

Start Times: Home>Settings>Offline Programs and Settings>Offline Programs>Edit Start Times

Water Days: Home>Settings>Offline Programs and Settings>Offline Programs>Edit Water Days

Zones: Home>Settings>Offline Programs and Settings>Offline Programs>Edit Zones

Set Seasonal Adjust: Home>Settings>Offline Programs and Settings>Seasonal Adjust

Controller - Manual Operation

You can run an irrigation zone on demand from the Hydrowise unit prior to having the

system connected to wifi.

Running a zone manually from the controller

From the **Home** screen, navigate to the **Zone Summary** screen by pressing **Zones**.

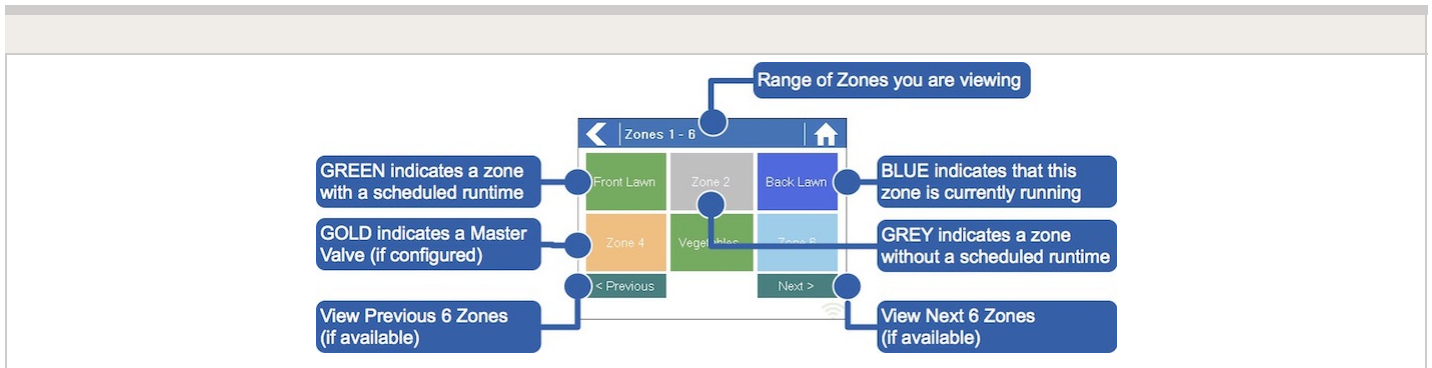

The Zone Summary screen shows the status of six zones at a time. To view the next or previous group of zones, use the **Next** and **Previous** buttons. The current range of zones that you are viewing is indicated at the top of the screen.

From the Zone Summary screen, touch the zone you wish to view.

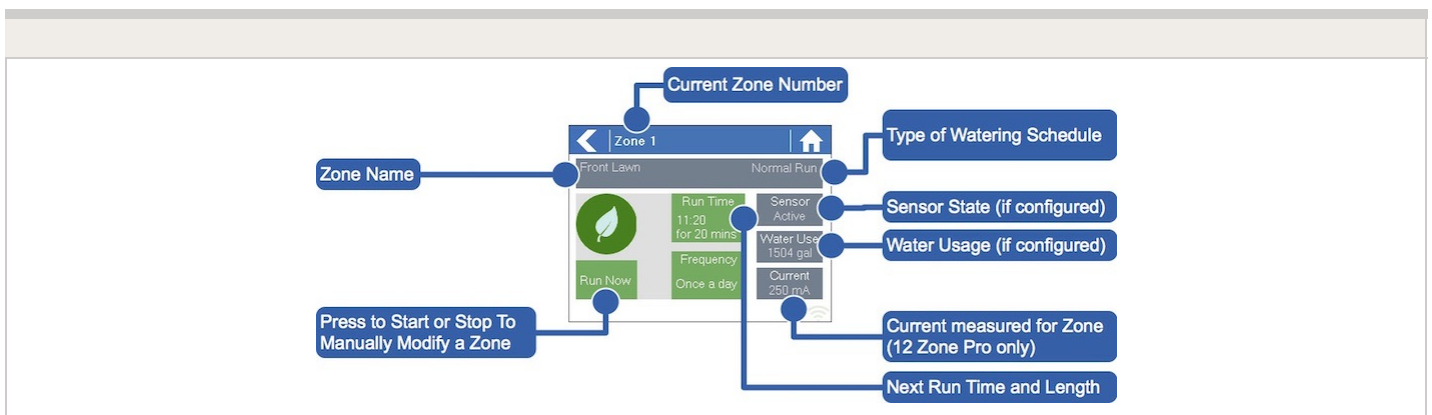

From the Zone Status screen, you can manually start a zone using the **Run Now** button. When started, the zone will run for the zone's default configured run length. This can be overridden by clicking on **Run Time** prior to manually starting the zone.

When a zone is running, the **Run Now** button will change to **Stop**. This allows you to stop a running zone.

Controller - Factory Default

Please follow the steps below to perform a factory reset on your controller. When the controller goes back online, the settings in the software will sync back into controller.

1. From the home screen, tap on **Settings**.
2. Next, press **Config**.
3. Press **Factory Default**.
4. Finally, press the **Erase Config**.

STEP 1



STEP 2

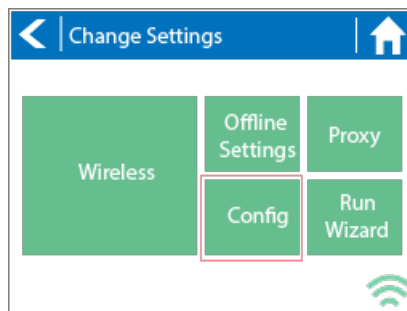

STEP 3

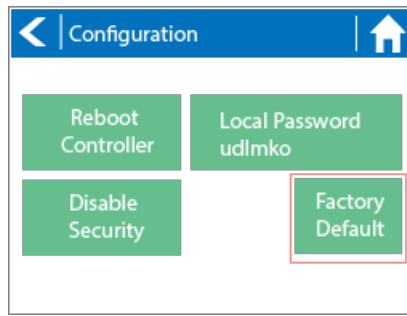

STEP 4

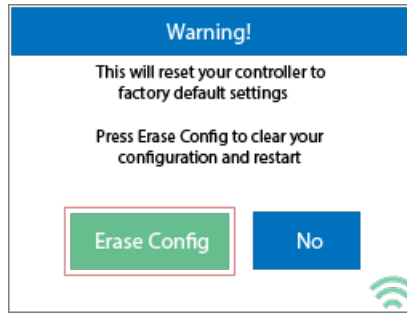

Congratulations, you have now successfully factory reset your controller. The controller is now ready for fresh configuration settings, either manually or automatically through synchronization with your Hydrowise account.

To link your controller to your account, refer to [Linking Your Controller to Your Account](#) ⁽⁶⁾.

Controller - Serial Number Location

Your controller's serial number is found on the rear of your controller or on the controller's touch screen.

Note: The serial number **A8000000** is a generic serial number assigned when the controller has not been registered (never connected to the internet to activate). This serial number will show on the touchscreen temporarily until the controller is connected to

internet. To see the real serial number, either to refer to the sticker or put the controller online so it updates to the correct online serial number.

To access the serial number on the touch screen, follow these steps:

From the Home screen, click **Status** > click **Controller Status**.

The serial number is shown on this screen. Depending on the model, you may see it at the top or bottom.

Note: The serial number contains only letters **a through f** and numbers **0 through 9**.

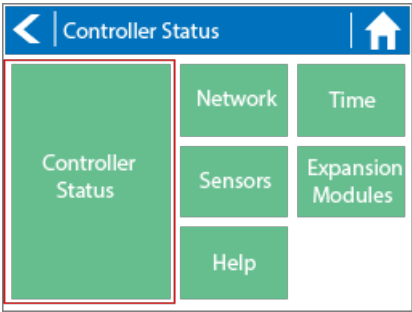
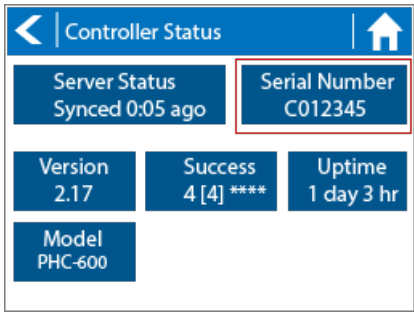
Serial Number on Screen	
<p>1.</p> 	<p>2.</p> 
<p>3.</p> 	

Serial Number Sticker

HC Controller - Sticker located on the back of the controller

PROHC - Controller - Located inside wiring compartment above the 24 VAC terminals

HPC - Controller - Sticker located on the back of the front panel

HCC - Controller - Sticker located on the back of the front panel

Serial Number 05EF3115



Contains FCC ID: 2ADDHKATWINC1500U

IC ID: 2ADDHKATWINC1500U

PHC 6 Zone Controller

To link your controller to your account, please refer to this article [Linking a Controller to My Account](#) [7].

Controller - Blank Display

First, make sure there is power to the controller's outlet. Use a test lamp or any other 110VAC device to determine if there is voltage at the outlet. If there isn't power, or if you have a controller that is hard wired, check the circuit breaker at the main breaker box.

Caution: High voltage testing on the transformers primary power side should only be done by a professional electrician or irrigation contractor.

Checking Transformer Voltage

If you have power at the outlet, the next thing to check is the transformer output. Use a voltmeter to check the voltage either on the two transformer wires or at the two AC screw terminals on the controller. The transformer should have an output in the range of 24VAC to 28VAC.

If the wall outlet has 110VAC and the transformer has no voltage output, you need to replace the transformer.

Cycle Controller Power

If you have voltage at both the wall outlet and the transformer output and you still have a blank display, try cycling the power on the controller. To cycle the power on the controller:

1. Remove power by unplugging the transformer from the wall outlet or by turning off the circuit at the breaker box.
2. Wait a few minutes.
3. Plug the controller transformer back into the electrical receptacle, or turn the breaker panel switch back on.

Note: If this doesn't restore the display, the controller will need to be replaced.

No Zones Running

In this article, we will cover the most common reasons why your sprinklers are not running.

Topics include the following:

- Testing water supply
- Testing controller voltage
- Test Wi-Fi on the controller

Test Water Supply

The water could be been shut off to the zone valves. Go to the zone valve and give the solenoid (where the wires are connected) a 1/2-turn counterclockwise. If the valves have water, the sprinklers will come on even without the controller. See the illustration below for activating the valve solenoid manually:

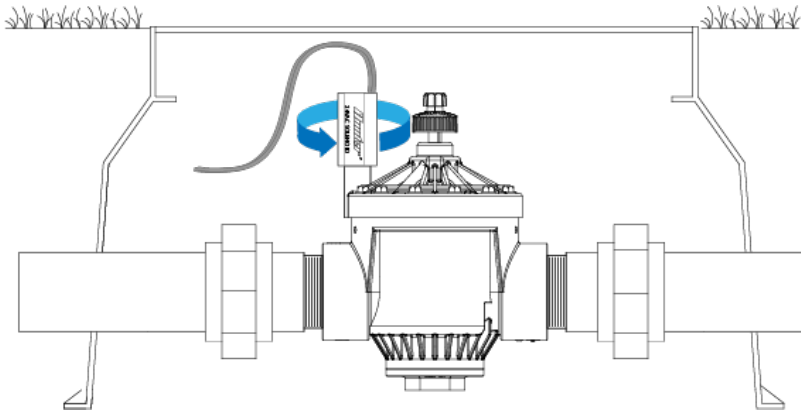

If the sprinklers turn on by manually twisting the solenoid, follow the next step to check for proper voltage.

Test Controller Voltage

To confirm proper voltage is getting to the valves using a voltmeter, follow the steps below:

1. From the **Home** screen, navigate to the **Zone Summary** screen by pressing **Zones**.

From the Zone Summary screen, touch the zone you wish to view. The Zone Summary screen shows the status of six zones at a time. To view the next or previous group of zones, use the **Next** and **Previous** buttons. The current range of zones that you are viewing is indicated at the top of the screen.

From the Zone Status screen, you can manually start a zone using the **Run Now** button. When started, the zone will run for the zone's default configured run length. This can be overridden by clicking on **Run Time** prior to manually starting the zone. When a zone is running, the **Run Now** button will change to **Stop**. This allows you to stop a running zone.

2. Use a volt meter to confirm there is 25–28 VAC at the screw terminals marked "C" and the corresponding station screw terminal (e.g., "C" and "2").
3. Next, go to the valve in question and check the same two wires connected to the valve for the same voltage.
4. If there is no voltage or low voltage at the valve, you may have a damaged wire or bad connection from the controller.
5. If you have necessary voltage (25–28 VAC) at the valve then the solenoid may need to be replaced.

If you need a new solenoid for the valve, Hunter makes our products and replacement parts available through our network of authorized distributors. Click on the following link to find an Authorized Hunter Distributor in your area: [Distributor Locator](#) ^[8]

Test Wi-Fi on the Controller

If the irrigation system did not water on the scheduled day, you may have a cancellation caused by a sensor or a water trigger. Refer to this [article](#) ^[9] if this is the case.

If your controller loses internet connectivity for more than one day, we'll send you an email notification. During this time, your controller will run the **last synced schedule** in offline mode.

NOTE: Without internet connectivity, your controller won't be able to automatically modify its watering schedule based on weather forecasts.

If the last synced schedule was for the controller to remain off, follow the steps below to reestablish the Wi-Fi connection.

1. Check that your wireless router and controller are powered on.
2. **Signal Strength check:** Settings > Wireless > Wireless Name > Select Network > Read strength (High recommended for optimal functionality).
3. **Reboot Controller:** Settings > Config > Reboot Controller > Check Server Status
4. **Factory Default:** Settings > Config > Factory Default > Erase Config > Connection Wizard > Check Server Status
5. **Reset Modem/Router:** Unplug for 15–20 seconds. Then plug back **three** times > Check Server Status. This will refresh the connection to an extender if you have one installed.
6. **Reset Extender:** Reset the extender as well to refresh IP settings.
7. **Check Network Settings:** The following Wi-Fi requirements apply to your Hunter Hydrawise-ready controller.
 - Hunter HC controller is 802.11 b/g
 - Hunter Pro-HC controller is 802.11 b/g/n
 - Hunter HPC controller is 802.11 b/g/n
 - Bandwidth: 2.4 GHz only; not compatible with 5 GHz
 - Router channel: Set between 1–11
 - Guest networks/networks with portal page login: Not compatible
 - Mac address (if needed):
 - HC: Enter 001e followed by serial number (e.g., 001e05fb90ce)
 - HCC/HPC/PROHC: Enter f8f0 followed by serial number (e.g., f8f005fb90ce)
8. **Testing with hotspot:** Depending on your smartphone, use either guide below:

Apple hotspot ^[10]

Android hotspot ^[11]

Check server status: This test will tell you if the controller is working properly and if you need to install an extender for better connection.

Wi-Fi Extender Note: You can try to connect to the extender via hotspot. If you have connection issues here, you not getting an internet connection from the source.

If controller will not connect to the hotspot, email the Support Team:

[Hydrawise Email Support](#) ^[12]

Sprinklers Running with the Controller Off or Unplugged

There are two reasons why sprinklers would continue to run with the controller **Off** or **Unplugged**:

- It's possible your valves were opened manually. Locate your valve box(es) and turn the solenoid(s) clockwise until snug. The solenoid is located on top of the valve and looks like a cylinder with two wires protruding out of it.
- It's also possible that debris in the valve is causing the diaphragm to remain open.

To fix this problem:

1. Disassemble the valve.
2. Rinse all parts with clean water.
3. Reassemble the valve.

If you cannot locate your valves, contact the contractor who installed the system.

Cleaning the Diaphragm on a Hunter Valve

Account - Resetting Password

If you registered using your email address (i.e., not using the Facebook option), click on **Forgot password?** from the [login](#) ^[13] screen.



Login to Hydrawise

[Forgot password?](#)

Log in

Or via



You don't have an account? [Register Now!](#)

On the next screen, simply type in your registered email address and click **Reset Password**. You will then receive an email. Click the password reset link and enter in your new password. Confirm the password and you should be good to go again.



Reset your password

Enter your email address below and we'll send you an email to reset your password.

[← Back to login](#) **Reset password**

If you are having issues logging in to Facebook using the application, follow this guide to reset your password: [Unable to Log In Using Facebook App](#) ^[14]. Don't worry; you won't lose any settings.

Account - Not Receiving Hydrawise Activation Emails

We're sorry that you have not yet received an activation email from support@hydrawise.com ^[15]. We use a third-party company to ensure our email has the best chance of getting to you.

The following tips will help you verify if the email was delivered. First, check your deleted items to see if the email was inadvertently deleted. If it was, move the email back to your inbox.

Next, look in your spam, trash, or junk folders. The email may have been sent to one of these folders due to email filters. If the email is in one of these folders, right click on the email and select "trust sender" or "always allow email from sender."

We recommend that you add support@hydrawise.com ^[15] to your "safe senders," "allowed," or "trusted" email list. Depending on your email service provider, you can do this in several ways. Below are shortcuts to some popular providers:

[Outlook](#) ^[16]

[Gmail](#) ^[17]

[Apple](#) ^[18]

Hydrawise does not use your email address for marketing purposes. To view our terms and conditions and privacy policy, visit www.hydrawise.com ^[19]. Please contact us if you have questions.

Account - API Information

Thank you for your interest! The Hydrawise API is coming soon...

Please register your interest with Anthony.Long@hunterindustries.com ^[20]

Thank You

Technical Support

Smart Voice Device - Amazon Alexa

In this guide, we will explain how to link your Amazon Alexa account with your Hydrawise account. Once you have linked your Alexa account to your Hydrawise account, you will be able to start, stop, or suspend zones using voice commands to your Alexa device. For example, you can say, "Alexa, ask Hydrawise to start Zone 1."

NOTE: Alexa supports only one controller per account. If you have multiple controllers linked to your account, Alexa does not know which controller you are referring to and will not be compatible. We now have Amazon Alexa approved for the following countries USA, Canada, Germany, and India.

Adding the Hydrawise skill to Alexa

To get started, you will need to make sure you have a Hydrawise account and have your controller configured. If not, please register for a free account [here](#). ^[21] Once you have your Hydrawise account ready, log in to your Alexa account (if you don't have one yet, you can register [here](#) ^[22]). The Alexa account and your Hydrawise account can have a different

email address without an issue.

1. Go to the **Skills** section on your Alexa Dashboard.
2. Search for the "**Hydrawise skill**," and select it.

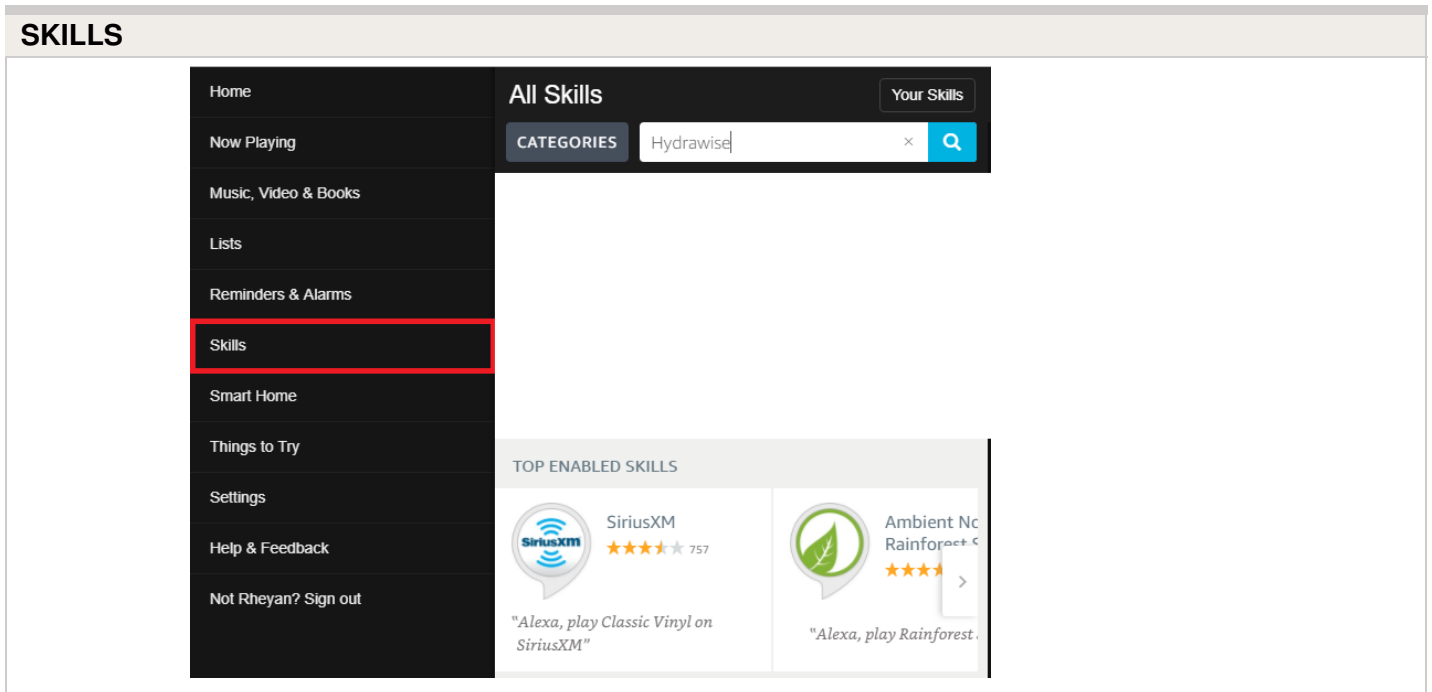

1. Click **ENABLE**.

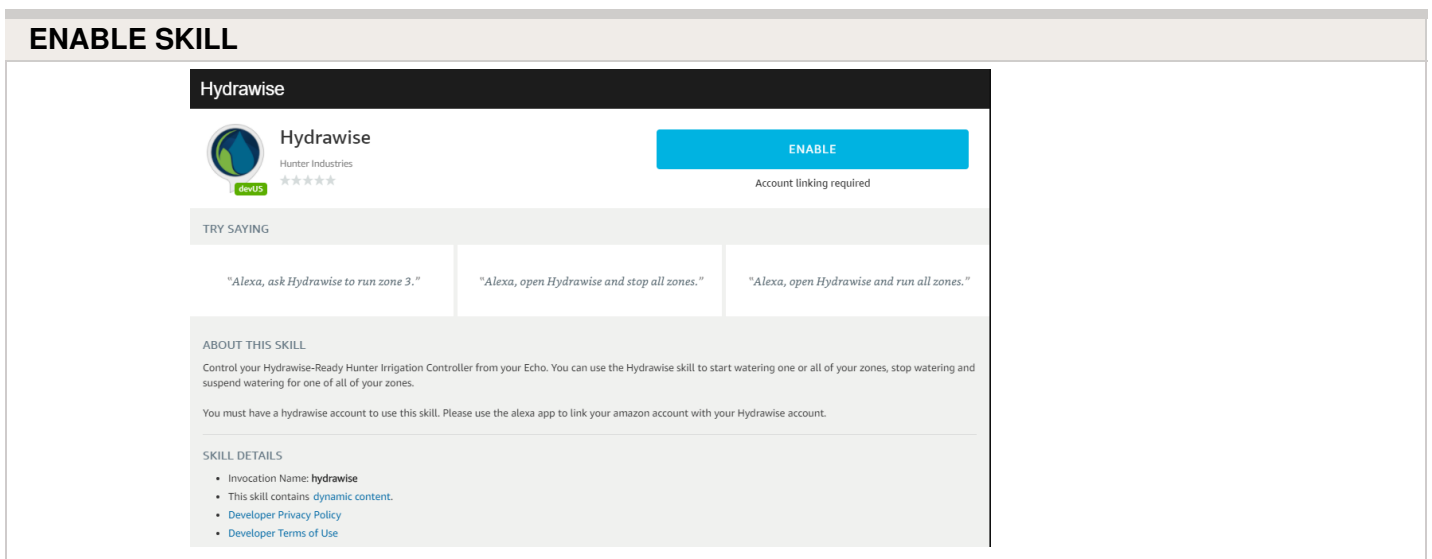

This will open a new window where you can log in to your Hydrawise account.

IMPORTANT: Please make sure you have pop-ups enabled for the Hydrawise log-in

window. If pop-ups are blocked, you will not be able to log in and continue the linking process.

LOG INTO HYDRAWISE

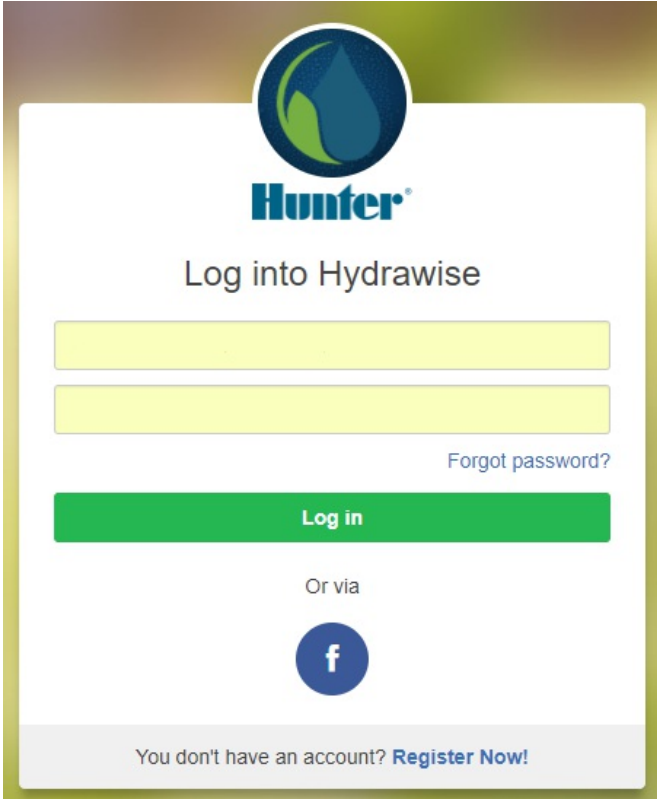

The image shows a login dialog box for Hunter Hydrowise. At the top is the Hunter logo, which consists of a blue and green circular emblem with a water drop shape, and the word "Hunter" in blue. Below the logo is the text "Log into Hydrowise". There are two yellow input fields for username and password. To the right of the password field is a link that says "Forgot password?". Below the input fields is a green button with the text "Log in". Underneath the button is the text "Or via" followed by a blue circular icon with a white "f" inside, representing Facebook. At the bottom of the dialog box is a grey bar with the text "You don't have an account? [Register Now!](#)".

If you are already logged in, you will see the next dialogue box appear.

AUTHORIZATION REQUIRED

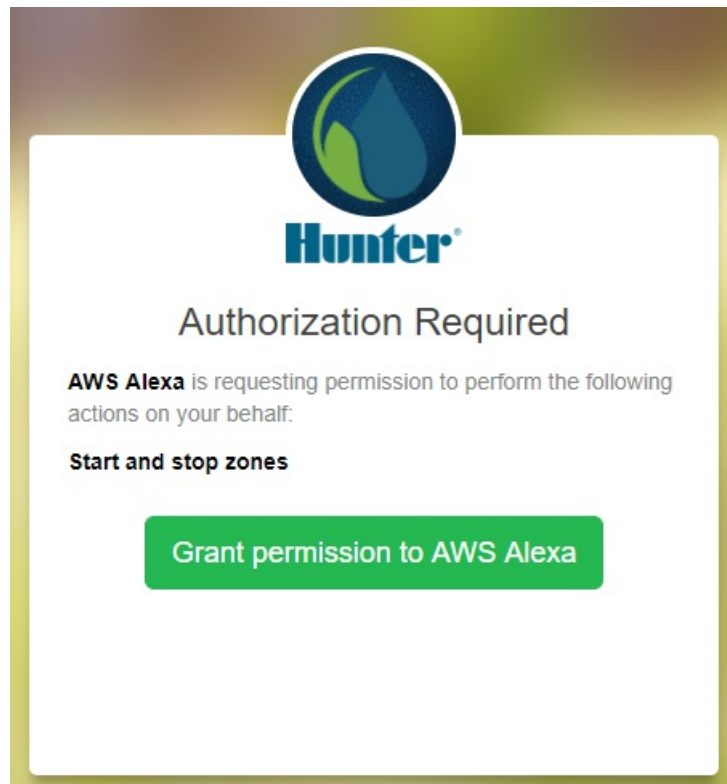

Click **Grant permission to AWS Alexa**.

You will then receive a confirmation that Hydrawise was successfully linked and you can close the window.

SUCCESSFULLY LINKED PAGE

The Amazon Alexa logo, featuring the word "amazon" in black and "alexa" in blue, with the Amazon smile arrow underneath.

Your Hydrawise Skill was successfully linked.

You can now leave this page

Using Alexa to control your Hydrawise

Zones can be started or stopped by referencing the zone number (do not use the zone name). For example, if your Zone 1 is called “Front Garden” and you want to start it, you can say, “*Alexa, ask Hydrawise to start Zone 1.*”

Alexa supports the following key phrases:

- Alexa, ask Hydrawise to start/run zone {number}.
 - This command will start a single zone for its default irrigation time.
 - e.g., *Alexa, ask Hydrawise to start Zone 5.*
- Alexa, ask Hydrawise to start/run zone {number} for {x} minutes.
 - This command will start a single zone for a specific time
 - e.g., *Alexa, ask Hydrawise to run Zone 1 for 10 minutes.*
- Alexa, ask Hydrawise to start/run expander {expander number} zone {number}.
 - This command will start a single zone on controllers with expansion modules
 - e.g., *Alexa, ask Hydrawise to start Expander 1, Zone 1.*
- Alexa, ask Hydrawise to start/run all zones.
 - This command will start all zones for their default irrigation time.
- Alexa, ask Hydrawise to stop/finish zone {number}.
 - This command will stop a single zone if it is currently running.
- Alexa, ask Hydrawise to stop/finish expander {expander number} zone {number}.
 - This command will stop a single zone on an expansion module.
- Alexa, ask Hydrawise to suspend zone {number} until {time/date}.
 - This command will suspend all zones for a period of time.

Home Automation - Control4

Hydrawise is now compatible with Control4 home automation software.

Control4 installers can now download drivers to allow the integration.

From the Control4 app, you can access the following features:

- View icons and zone information
- View proposed watering
- Manually start a zone
- View active (watering) stations

NOTE: More details on Control4 integration can be found using this link: [Control4 Details](#)

[23].

Account - Translation Options

Steps to take to change language via Google Chrome

To change the language in google Chrome, please follow the steps below.

Once you have downloaded and installed [Google Chrome](#) [24], you can then change the language to your desired language.

When you are logged in to your account, right-click anywhere along the top of the dashboard and select **Translate to English**.

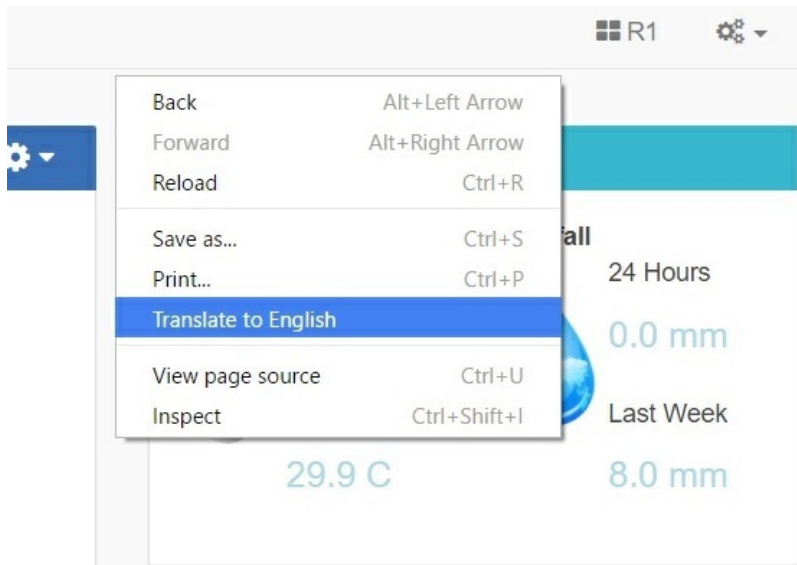

Once you have clicked **Translate to English**, the next dialogue box will appear. Click on **Options**.

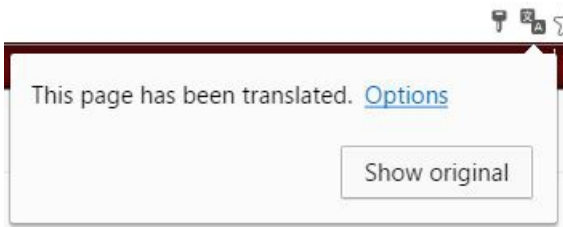

You will then be brought to the next two dialogue boxes:

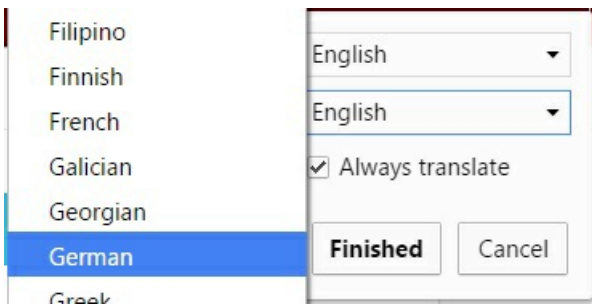
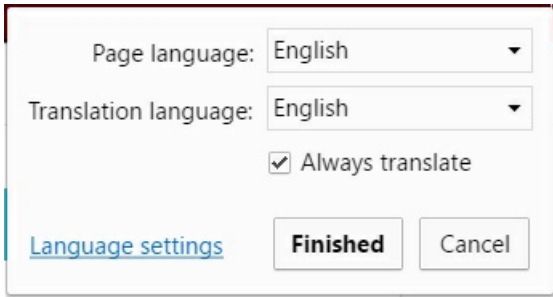

From here, you can select the language of choice. You also have the option to check **Always Translate**.

NOTE: Translation sometimes does not occur automatically when you click to navigate to another page. When this happens, press F5 or click **Refresh** to refresh the page. Follow the steps again from the top to translate the page to the language of choice.

This example shows the page translated in German:

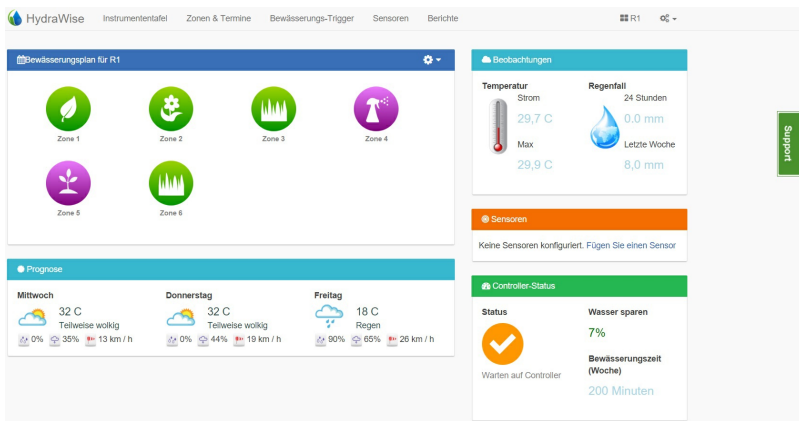

IMPORTANT: Please keep in mind that because translations are performed by Google Chrome, there may be some inaccuracies.

This method can also be used when going through our [Help Guides](#) ^[25] here on Zendesk. If you need further assistance, email us at support@hydrawise.com.

iOS and Android App Support Policy

The Hunter Hydrowise app's general policy is to support Android and iOS version for as long as the manufacturer (ie. Google or Apple) supports their operating system version.

It is important to use an Android or iOS version that is supported by Apple or Google to ensure you have the manufacturer's latest security updates to protect your data.

As of July 2019, Google officially supports Android 7.0 (Nougat) and above. Apple officially supports iOS versions 12.3 and above.

While we do our best to maintain support for older versions, changes in technology mean that sometimes it is not possible to add features to our apps whilst maintaining backward compatibility with unsupported versions of Android or iOS.

While not supported, we do have customers using older versions of Android (eg. Android 5.0) and iOS (eg. iOS 10.0) without issues.

If your app does not work with your unsupported version of Android or iOS, it may be possible to use your Hydrowise system via the web browser (www.hydrawise.com ^[19]) in the

older device.

Offline Programming - Standard

Standard programming will allow the controller to run like our traditional controllers the X-core and the Pro-C models. Each of the six programs (a-f) allows you to start each program up to four times a day, set run lengths and set specific days to water. The standard mode is on version **4.01** or higher. If your controller is not on this version and you have no internet connection, then you will need to connect to the internet via [hotspot](#) ^[26] and [switch modes](#) ^[27]. When you switch modes when on the [hotspot](#) ^[26], your controller will automatically upgrade to version 4.01.

To set your controller to **Standard Offline Mode** for manual configuration, please follow the steps below:

1. From the main menu, tap on **Settings**.
2. Select **Offline Programs & Settings**.
3. Select **Disable Wi-Fi**.
4. You will be presented with a warning dialogue. Please make sure you understand the warning before proceeding. If you're sure that you want to go offline, tap **Go Offline**.
5. Select **Offline Mode**.
6. Select the **Standard Mode** option and press **Confirm**.
7. Select **Offline Programs**.
8. Select the **Edit Water Days** option. The choices here would be specific days, odd/even or interval (e.i. interval 2 would water every other day). Select **OK**.
9. Select the **Edit Start Times** option. You can set up to four start times for each of the six programs. Remember, each start time will sequentially run through all the zones one after another. Select **OK**.
10. Finally, select the **Edit Zones** option. Select the zone, then check the box **Zone Enabled** to allow you to add run time for that zone. Select **OK**.

The basic program should be complete!

Step 1



Step 2

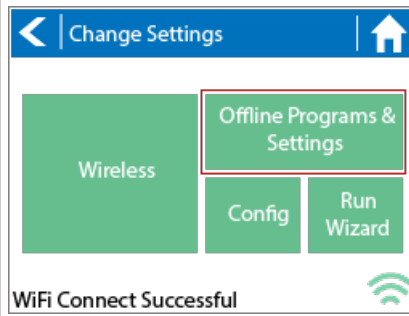

Step 3

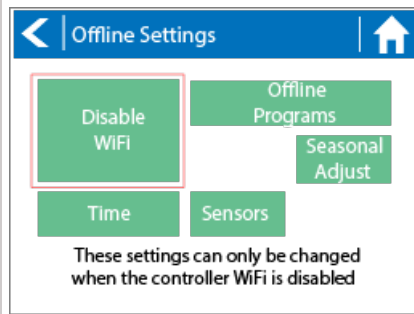

Step 4

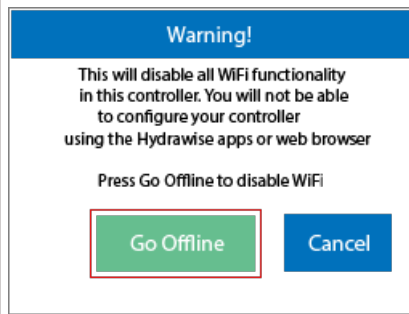

Step 5

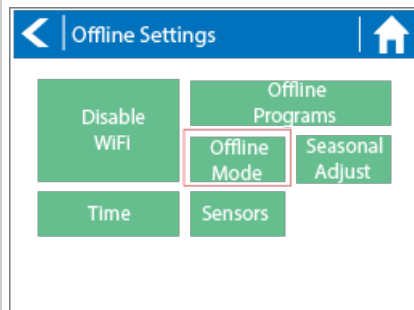

Step 6

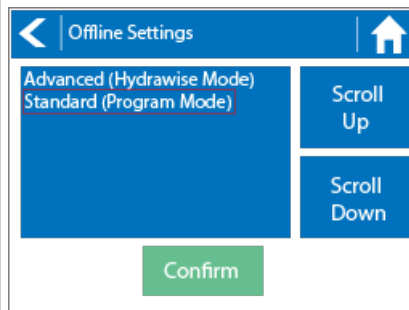

Step 7

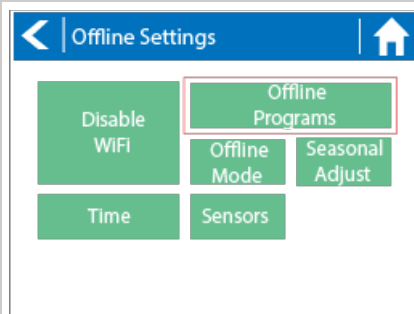

Step 8-A

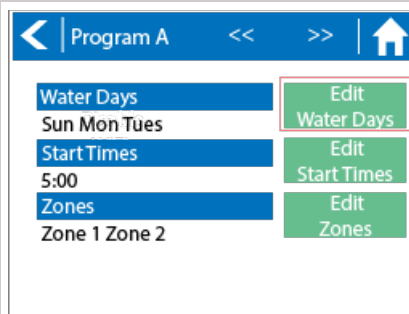

Step 8-B

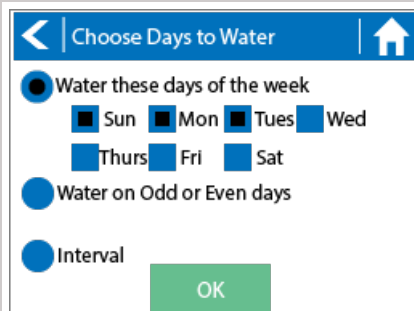

Step 9

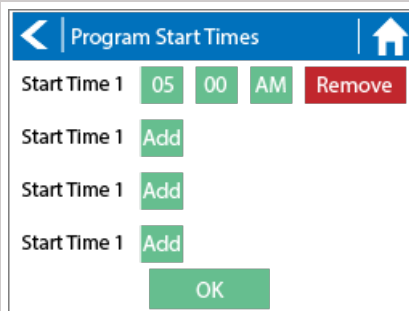

Step 10

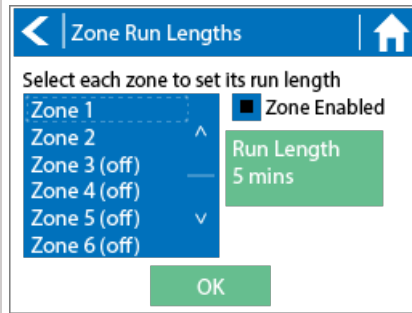

Offline Mode - Accessing Offline Mode

Offline Mode

If the controller loses its internet connection for more than 24 hours, you'll receive a notification email. The controller will then go into offline mode. In offline mode, your controller won't be able to access local weather conditions such as rainfall or evaporation. As a result, it will revert to a predefined program.

- For **Smart Watering** zones, the controller will adjust each zone's watering length based on your offline watering budget and will water at each zone's configured peak watering frequency.
- For **Time-Based Watering** zones, the controller will adjust each zone's watering length based on your offline watering budget and will water at each zone's configured watering frequency.
- Note that **Cycle and Soak** is not supported in offline mode and each zone will water for its full watering length without pausing.
- The controller will only water at your configured **Program Start Times**.

To set your controller to **offline Mode** for manual configuration, please follow the steps below:

1. From the main menu, tap on **Settings**.
2. Tap on **Offline Settings**.
3. Tap on **Disable Wi-Fi**.

4. You will be presented with a warning dialogue. Please make sure you understand the warning before proceeding. If you're sure that you want to go offline, tap **Go Offline**.
5. Now that your controller is in Offline Mode, you can configure it manually by tapping on **Program Start Times**.
6. From this screen, you can manually configure each zone according to your desired schedule. Simply tap on **Add** to add a program start time and follow the steps below. You can toggle between zones by tapping on **Next/Previous** or you can leave the start time to **APPLY to ALL ZONES**.

Applying the start time to **ALL ZONES** will run through all zones with a single start time.

- Tap **ADD** in the start times menu.
- Select the green box upper in left to enter **PROGRAM START TIME (24 hr format)**
- Tap the **DAYS** to be selected **after** finished with start time entry.
- Tap **CONFIRM** to save the start time entry.
- Add a second start time for all zones or single zone if desired.
- Tap the **HOME** icon (upper right) to allow station run times setup.

NOTE: Each zone can have up to four program start times and an additional four start times under the **All Zones** section as shown below.

7. From the home screen, you can manually configure each zone run time. Simply tap on **ZONES** to add a zone run time and follow the steps below. You can toggle between zones by tapping on **each zone number**.

- Tap **ZONES** in the home menu.
- Tap the first zone to edit, (**For Example: ZONE 1**).
- Tap on **RUN TIME** in the center of the screen.
- Enter **RUN TIME (minutes:seconds format)**, then press **OK** to save entry.
- Repeat steps **1-4** for station run times.

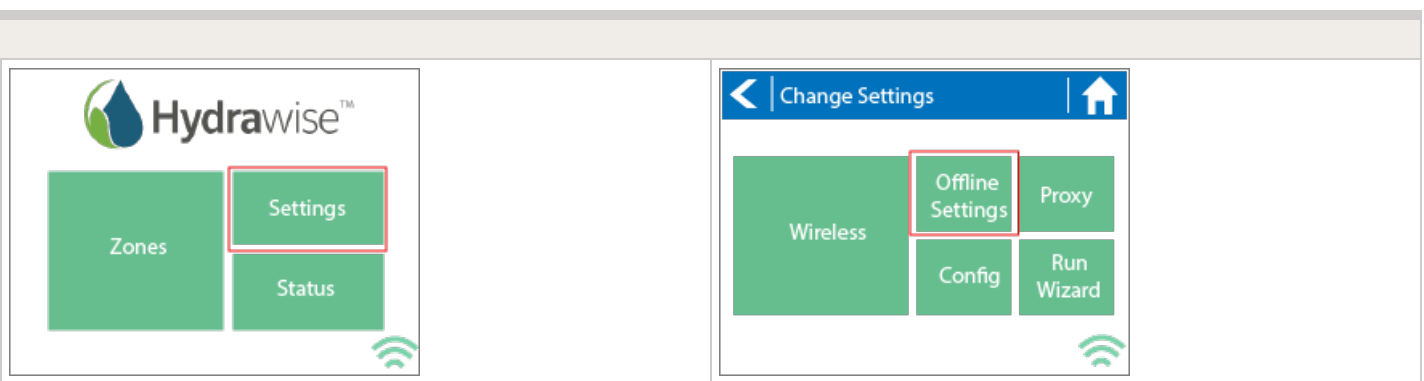

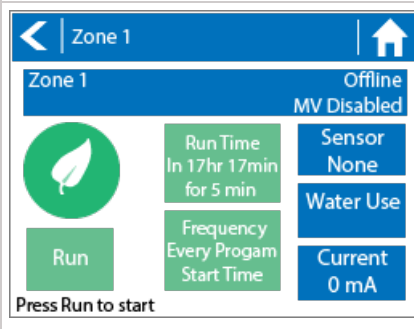
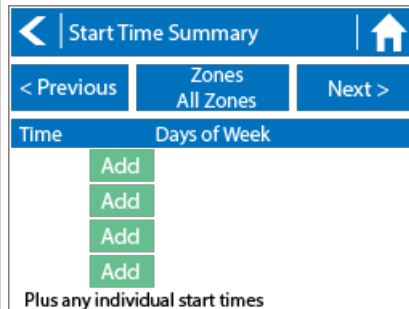
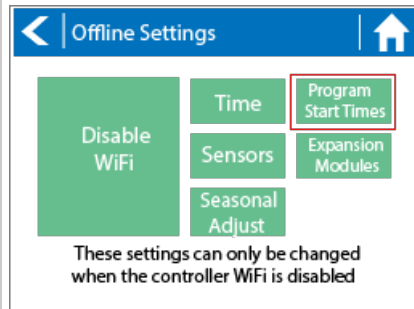
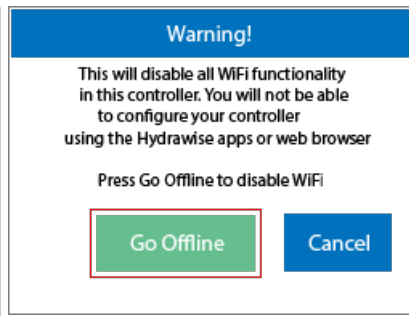
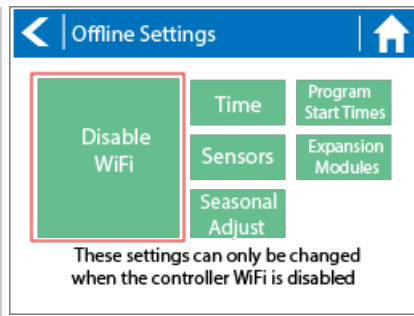

NOTE: To get your controller back in online mode, follow the above steps, enable Wi-Fi, reconnect to your SSID (Wi-Fi connection), and let the controller synchronize with your online Hydrawise account.

Offline Mode - Run the Setup Wizard

Please follow the steps below to run the setup wizard in offline mode. Refer to [Setting Controller to Offline Mode](#) ^[28] or [How to Factory Reset Controller](#) ^[29] before running the wizard.

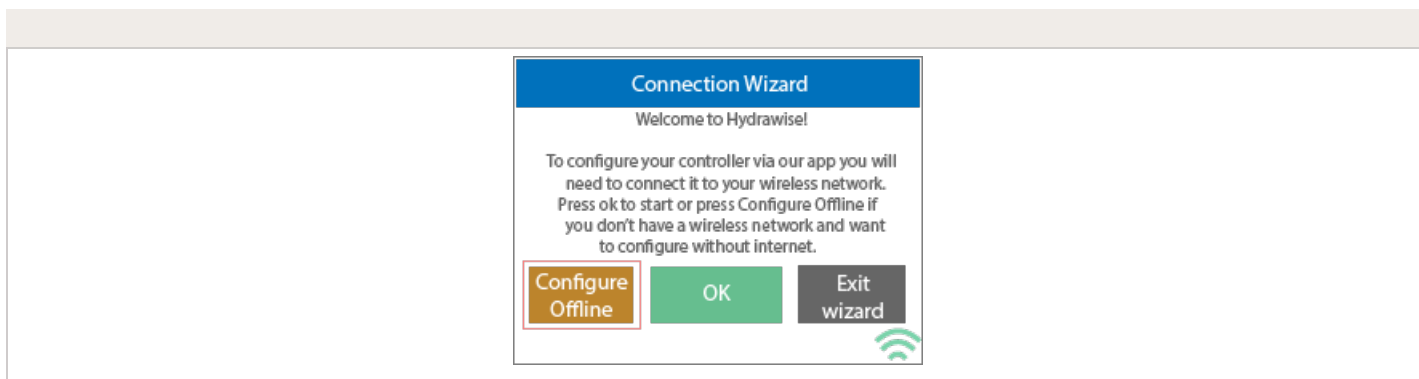

1. From the **Connection Wizard screen**, tap on **Configure Offline**. If you select **OK**, you will proceed to the online setup wizard.
2. Tap **OK** to move on to the next step.
3. Enter in today's date if it hasn't already been set or if it is incorrect.
4. Enter today's time if it hasn't already been set or if it is incorrect.
5. From this screen, tap **OK**.
6. Please assign your **Master Valve** if you're running one as advised on the previous screen. Otherwise, keep **Not Assigned** selected and tap **Confirm**.
7. Tap **OK**.
8. You can now enter (in minutes) the run length you want for your **default zone run time**. Then tap **OK**.
9. Tap **OK** to proceed to the next screen.
10. Next, set how often each zone will run. As advised on the previous screen, you can set individual frequencies for each zone.
11. Tap on **OK** to proceed.
12. From this screen, you can manually configure each zone according to your desired schedule. Simply tap on **Add** to add a program start time and follow the steps below. You can toggle between zones by tapping on **Next/Previous** or you can leave the start time to **APPLY to ALL ZONES**.

Note: Each zone can have up to four program start times and an additional four start times under the All Zones section as shown below. Applying the start time to ALL ZONES will run through all zones with a single start time.

1. Tap **ADD** in the start times menu.
2. Select the green box upper in left to enter **PROGRAM START TIME (24 hr format)**
3. Tap the **DAYS** to be selected **after** finished with start time entry.
4. Tap **CONFIRM** to save the start time entry.
5. Add a second start time for all zones or single zone if desired.
6. Tap the **HOME** icon (upper right) to allow station run times setup.

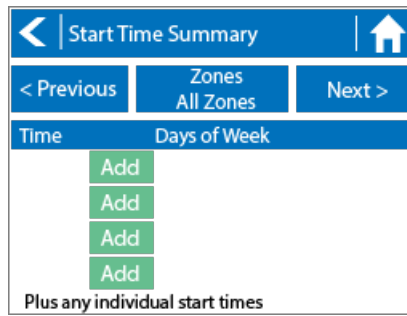

From the home screen, you can manually configure each zone run time. Simply tap on **ZONES** to add a zone run time and follow the steps below. You can toggle between zones by tapping on **each zone number**.

Note: The default run time and default watering frequency are applied to all zones during the setup wizard. Setting individual run times and frequencies is done by going into each zone afterwards

1. Tap **ZONES** in the home menu.
2. Tap the first zone to edit, **(For Example: ZONE 1)**.
3. Tap on **RUN TIME** in the center of the screen.
4. Enter **RUN TIME (minutes:seconds format)**, then press **OK** to save entry.
5. Repeat steps **1-4** for station run times.

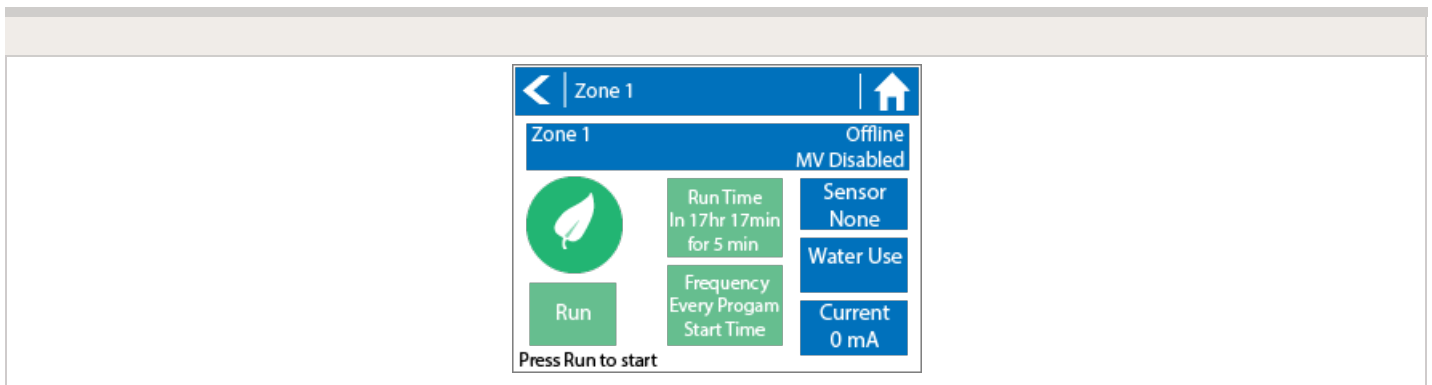

NOTE: To get your controller back in online mode, follow the above steps, enable Wi-Fi, reconnect to your SSID (Wi-Fi connection), and let the controller synchronize with your online Hydrowise account.

Offline Adjustments - Watering with no Internet

If your controller loses internet connectivity for more than one day, we'll send you an email notification. During this time, your controller will run the last synced schedule in offline mode.

Offline watering adjustments apply when your controller is not connected to the internet after 30 minutes.

You can access this setting from the **Controller Settings** tab on your home dashboard.

□

In offline mode, the controller will set watering times based on watering adjustments set up beforehand.

If the next irrigation event for a zone was scheduled for Saturday, offline mode for that zone would start after the irrigation event on Saturday if the controller didn't have the internet. If there are no irrigation events scheduled in the controller when it loses the internet, offline mode will start **30 minutes** after the controller loses internet.

NOTE: Without internet connectivity, your controller won't be able to automatically modify its watering schedule based on weather forecasts.

Offline Mode - Sensors

Please follow the steps below to add and configure your sensor or flow meter in **Offline Mode**. Please use the following link for [Installation Instructions](#) ^[30].

1. From the main menu, select **Settings**.
2. Next, select **Offline Settings**.
3. Select **Sensors**.
4. From this screen, you can now navigate between **Sensor 1** and **Sensor 2** by using the **Next** and **Previous** options. Just as you configure your sensors online, you can select the different options to make changes accordingly.

STEP 1



STEP 2

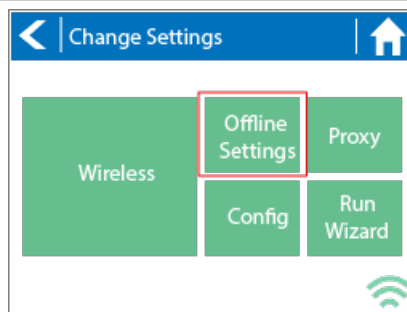

STEP 3

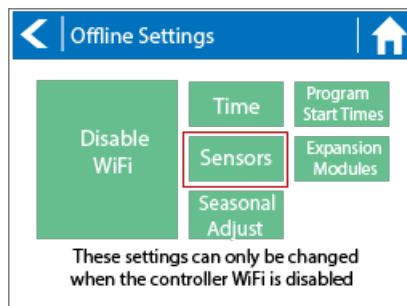

STEP 4

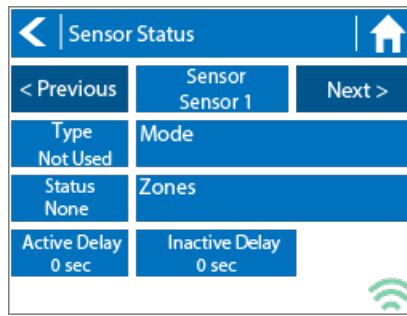

Sensor Status Options	
Type Options	Not Used, Level (Rain Sensor) or Flow Meter
Mode	Stop when open, Stop when closed, Start when open, or Start when closed.
Status	Open or Closed
Zones	Applies to all zones
Active Delay	Seconds
Inactive Delay	Seconds

Offline Mode - Turning Off Start Times

From the controller, you can manually turn it off by removing the start time when the controller is NOT connected to Wi-Fi using offline mode. Please follow the steps and screenshots listed below:

1. Select "**Settings**" in the home menu at the controller.
2. Select "**Offline Settings.**"
3. Select "**Program Start Times**" on the upper right side of the screen.
4. Select "**Modify**" which will allow you to edit you start times.
5. Finally, Select "**Delete**" button to no longer allow controller to run in offline mode.

Step 1



Step 2

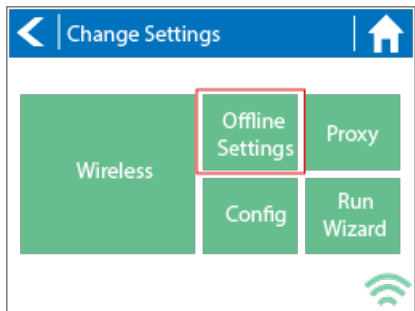

Step 3

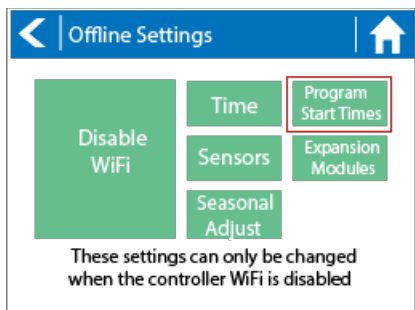

Step 4

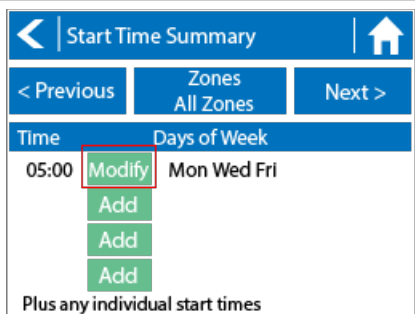

Step 5

← Edit Program Start Time →

Time
05:00

Odd Days
Even Days

Sunday
Monday
Tuesday
Wednesday

Thursday
Friday
Saturday

Confirm Delete

Offline Mode - Seasonal Adjust

Offline water adjustments allow the controller to automatically adjust the amount of watering on a month by month basis if the controller is in an Offline mode (ie. not connected to the internet). Steps below will cover both online and offline instructions on changing the seasonal adjust for when the controller enters offline mode.

Online: Offline Water Adjustment

1. Select **Controller Settings** on the left hand side.
2. Select **Offline Adjustments**.
3. Sliders can be moved to adjust the offline watering from 0%-300%.

STEP 1-2

Profitt Landscapes, Inc.

Carioca Court
PROFFITT LANDSCAPES

Home
Zones & Schedules
Watering Triggers
Sensors
Controller Settings
Reports

Settings

Controller Settings Weather Stations Expanders **Offline Adjustments**

Offline watering

1 January
2 February
3 March
4 April

STEP 3

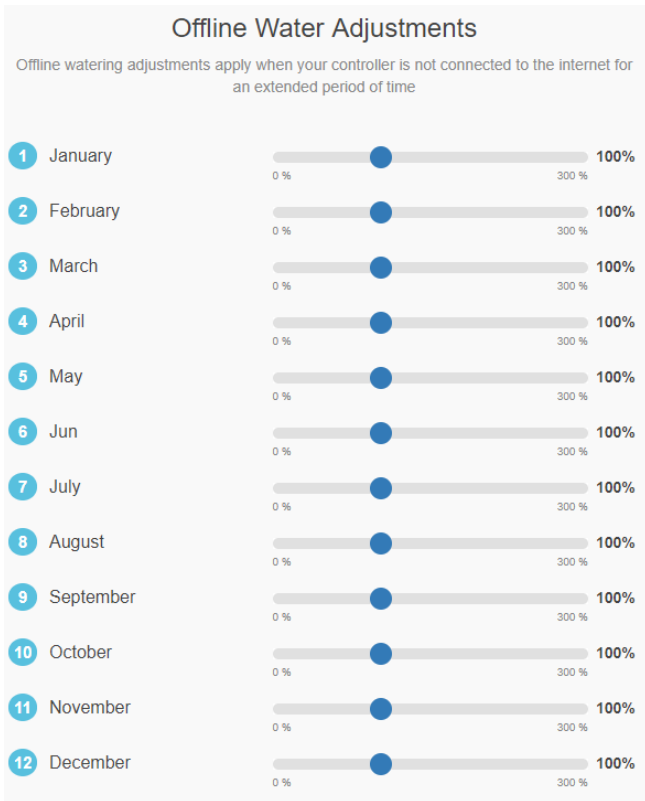

Offline: Offline Water Adjustment

1. Select settings.
2. Next, select offline settings.
3. Select seasonal adjust.
4. Select a month to adjust.
5. Adjust each month by a percentage then select OK.

CONTROLLER SCREENSHOTS:

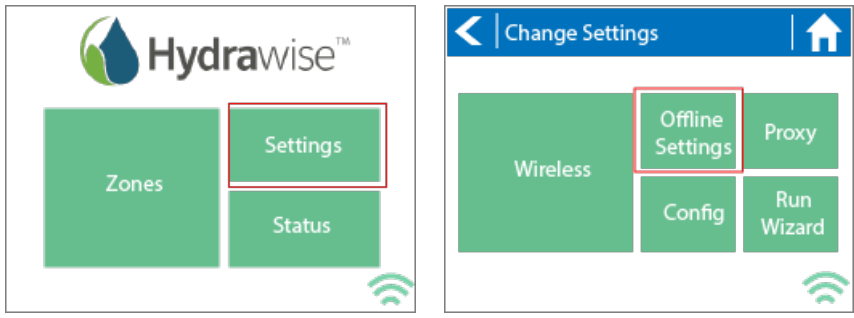

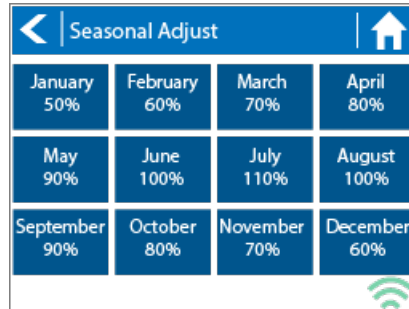
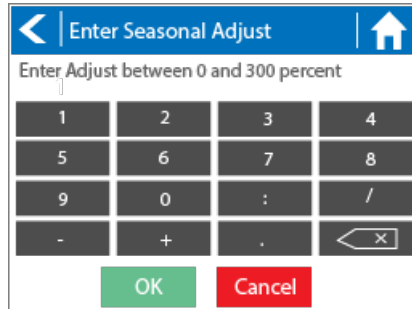
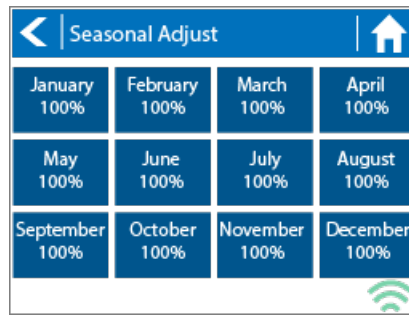
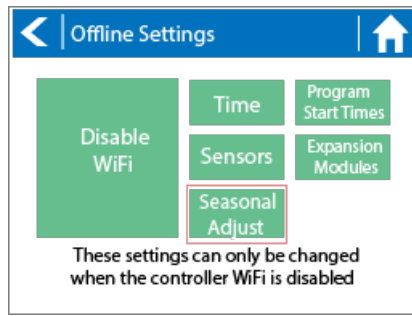

HPC - Upgrading Pro-C

The PROC model controller must be the NEWER 400 version with a date code of MARCH 2014 or newer. Ensure you have a strong Wi-Fi signal. Wi-Fi connectivity can be tested on

the HPC panel itself (signal strength is shown when you select a wireless network). If you have any issues connecting the controller to the router, please verify all Wi-Fi specifications [here](#) ^[1].

Remove Pro-C Face Panel

1. Remove ribbon cable with power off.
2. Press down on white hinge release button.
3. Remove face panel.

Install HPC-FP Face Panel

1. Press blue hinges together and attach new HPC panel.
2. Reconnect ribbon cable
3. Close and turn power on

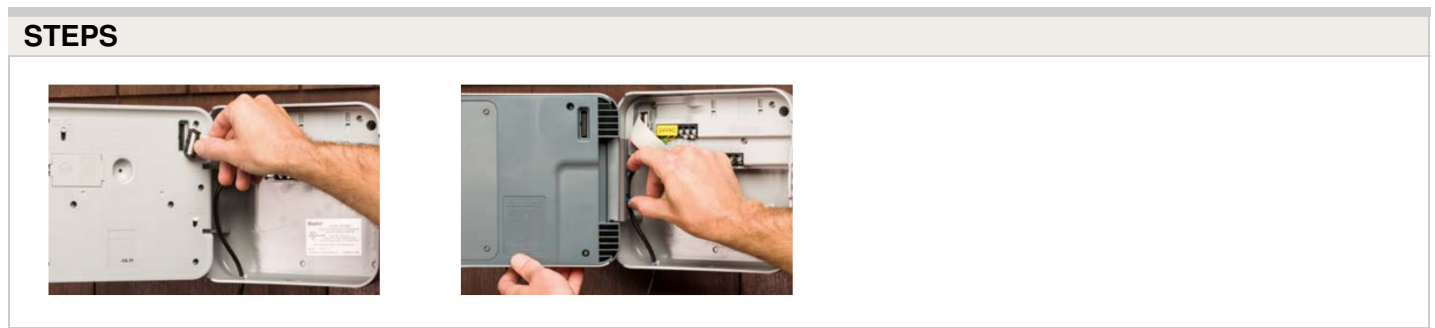

For information on complete setup in the application, please visit our "[How To Guide](#) ^[31]" section.

HPC/HCC - Using Hunter Remotes

The HPC face panel quickly and easily upgrades Pro-C® controllers (PC400 models manufactured since March 2014) to next-generation smart controllers via the Hydrawise platform. In addition, it lets contractors continue using their Roam and Roam XL remotes for quick on-site management. HCC is also compatible with Hunter's ROAM and ROAM XL remotes, allowing for fast and reliable manual operation in the field from long-range

distances without the need for a smartphone. There is no need to remove the smart port adapter from the controllers when doing a facepack upgrade.

Compatible models include all Hunter remotes: **SRR, ICR, ROAM, and the ROAM-XL.**

If the Smartport is not installed on the controller, see illustrations below for wiring instructions.

Note: Any extension of the wiring on the SmartPort may result in an error message in the controller display and possible malfunction of the remote unit due to radio interference. In

some situations, lengthening of the harness may work fine, in others it may not work at all (it is

site specific). In either case, extending the wiring harness should be done using shielded cable to

minimize the possible effects of electrical noise. For easiest installation, order the Hunter SmartPort shielded cable wiring harness. (P/N ROAM-SCWH) with a full 25' (7.6 meters)

of shielded cable.

Wiring

1. Bottom 24 VAC terminal - Red wire
2. Second 24 VAC terminal - White wire
3. Remote terminal - Blue wire

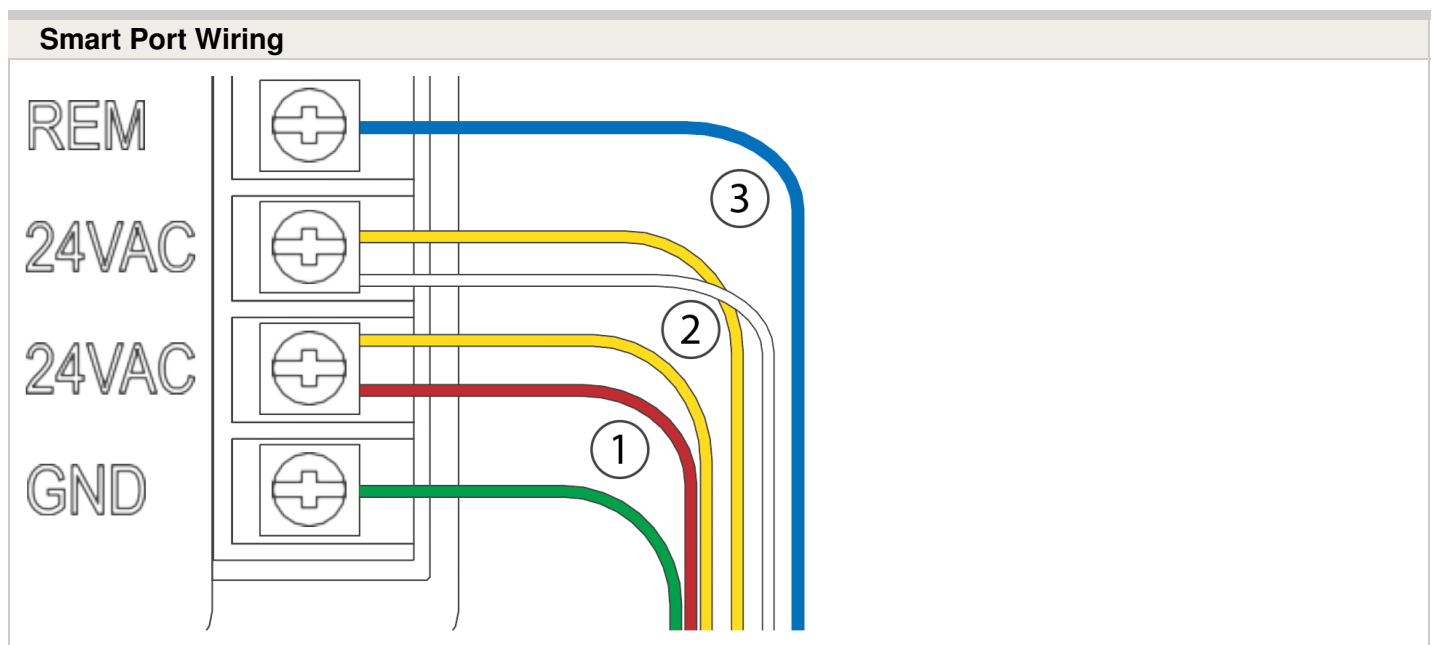

Operation

The ROAM System will allow you to remotely turn on and off any station on your Hunter controller with the press of a button. Once on, the station will run for the run time you have designated in the remote. To remotely activate a **station**, follow the steps below:

1. Plug the receiver into a SmartPort® that is connected to a powered controller. The receiver will beep 4 times followed by a 10-second pause and a single beep.
2. If your transmitter is not on (no display), wake it up by pressing and holding the **MODE** button for 5 seconds. The Transmitter will display the active station.
3. Use the **up** and **down** buttons to display the station you would like to start.
4. Press the **"Green Play Button"** to start the station. The Transmitter will display the Transmit icon . If you are near the receiver, you will hear it beep 2 times. This indicates that the Receiver has received the command.
5. Press the **"Red Stop Button"** to turn off any station that is on. The display will show the Transmit icon and receiver will beep again twice. The ROAM System is designed to turn on one station at a time (unless you activate a program). Therefore, turning a station on while another station is operating will cause the operating station to turn off.

NOTE: The ROAM remote can activate any station on the controller whether the controller dial is in the "SYSTEM OFF", "RUN" or "RUN/BYPASS SENSOR" modes. If a sensor device has been wired to the controller, the ROAM remote will NOT override the sensor for manual operation. For more programming information, please see attached manuals for both the ROAM and ROAM XL remotes.

HCC - Valve Wiring

1. Route valve wires between control valve location and controller.
2. At valves, attach a common wire to either solenoid wire of all valves. The most commonly used color for the common wire is white. Attach a separate control wire to the remaining wire of each valve. All wire splice connections should be done using waterproof connectors.
3. Open hinged faceplate on the controller to access the terminal strip area.
4. Route valve wires through the conduit and attach conduit to the controller at the large conduit opening on the right side of the bottom of the cabinet. The conduit opening has

a triple knockout to accommodate 1", 1¼", or 1½" (25, 32, or 40 mm) conduit. Each section can be easily removed using a knife.

- Strip ½" (13 mm) of insulation from ends of all wires. Secure valve common wire to **C** (Common) terminal on any of the valve modules or power module. Then attach all individual valve control wires to appropriate station terminals.

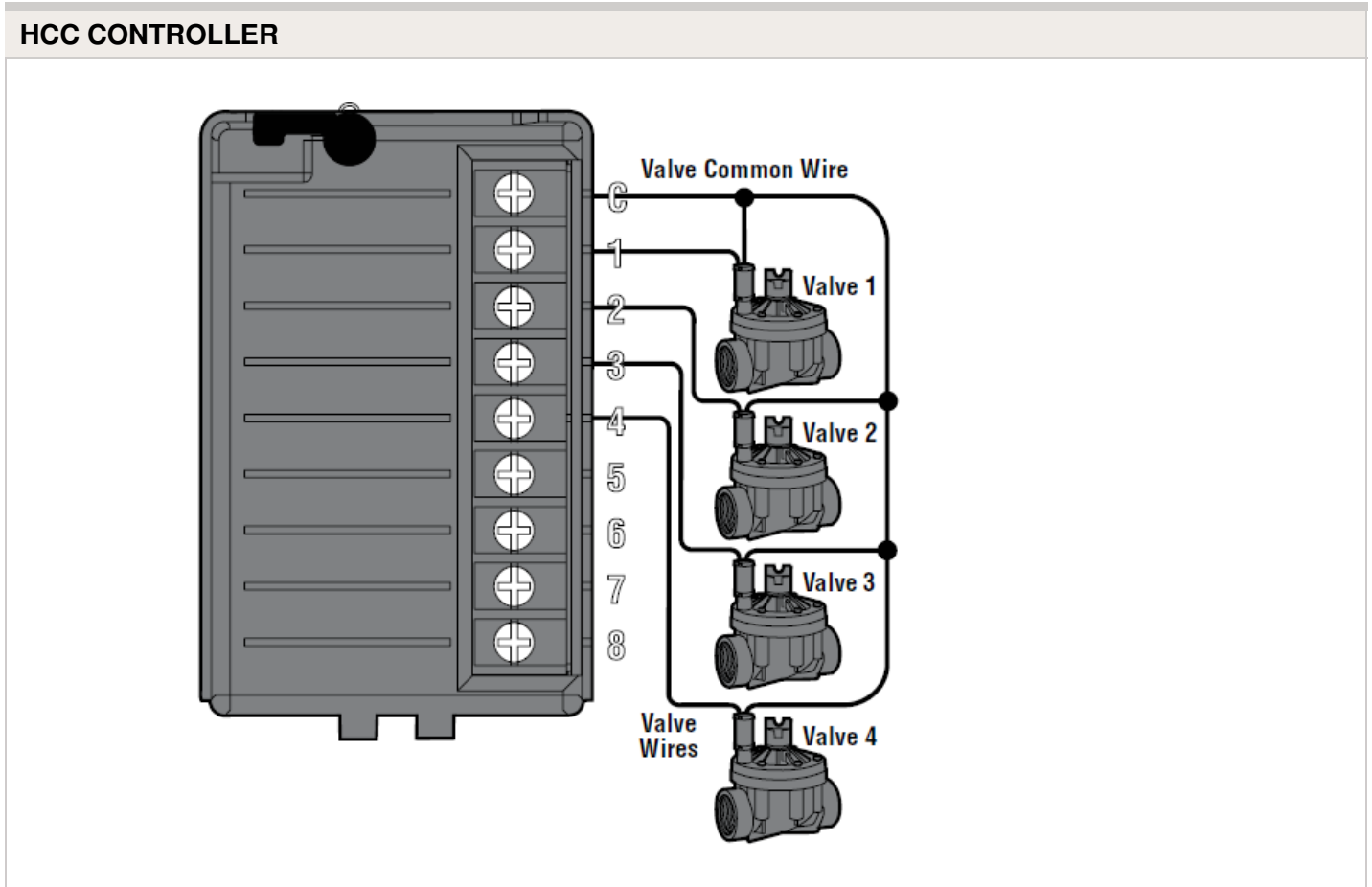

HCC - AC Wiring

Connecting the controller to primary AC power should be done by a licensed electrician following all local codes. Install in approved conduit and fittings. The controller can operate with either 120VAC or 230VAC power. Supply wires must be 14AWG/ 2 mm² or larger.

- Turn AC power **"off"** at the source, and verify that it is off.

2. Disconnect the **"facepack"** ribbon cable.
3. Remove the **"facepack."**
4. Remove the **"cover"** from the junction box.
5. Strip about **0.5"** (13 mm) of insulation from the end of each AC power wire.
6. Route the wires through the **"conduit opening"** inside the junction box.
7. Connect AC wiring using supplied terminal block (or taped wire nuts where permissible).

2a.

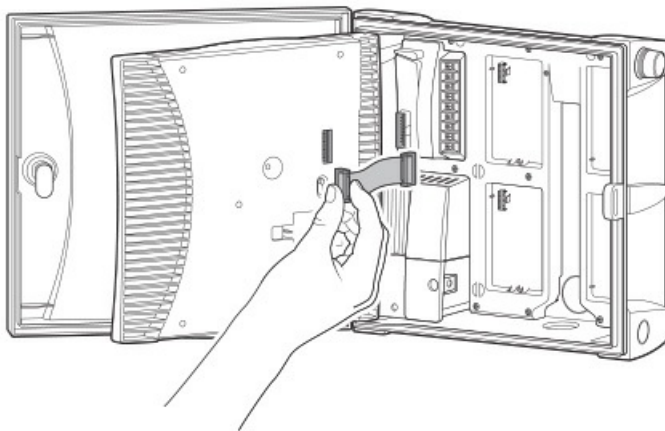

2b.

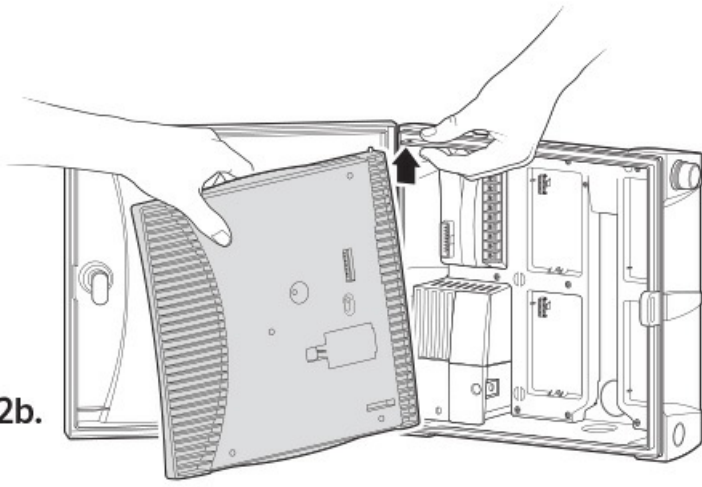

2c.

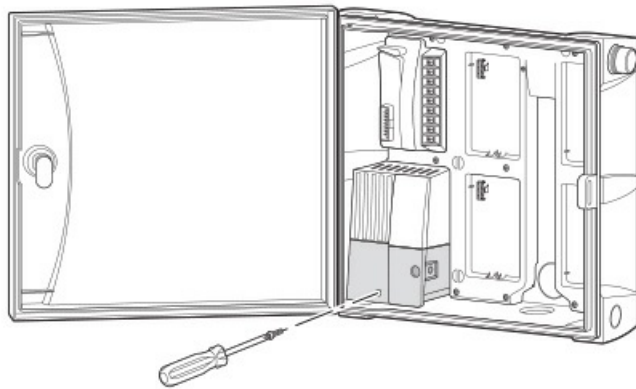

Wiring Block

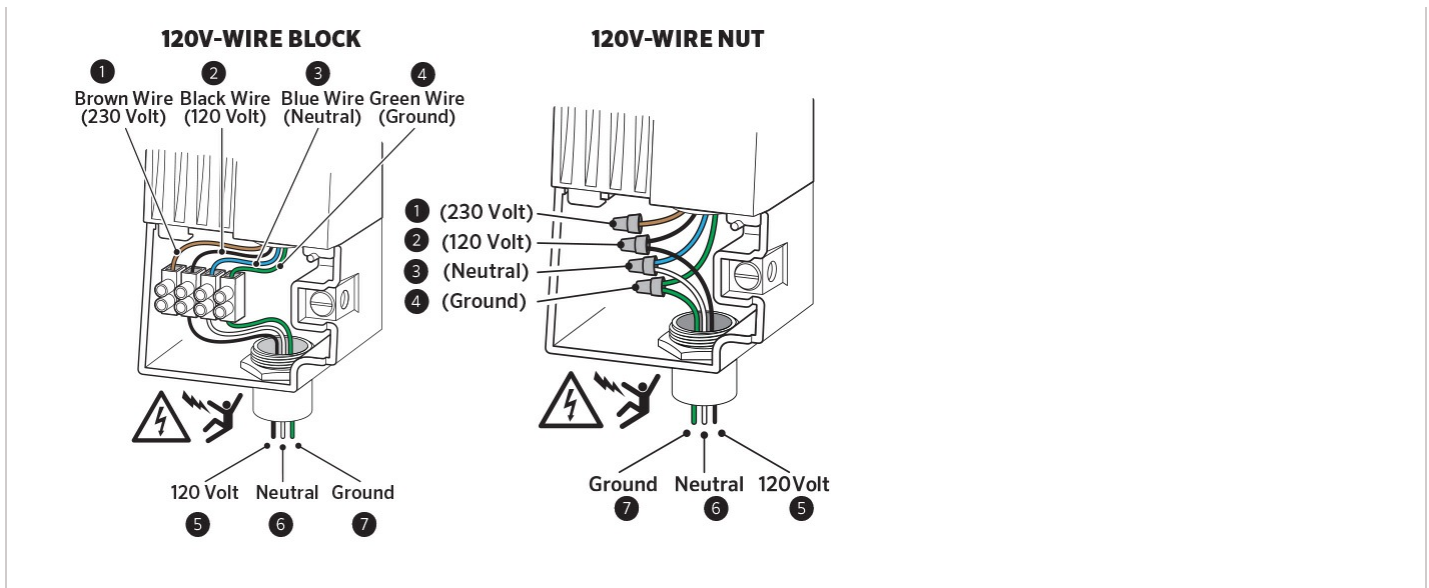

Wiring Block

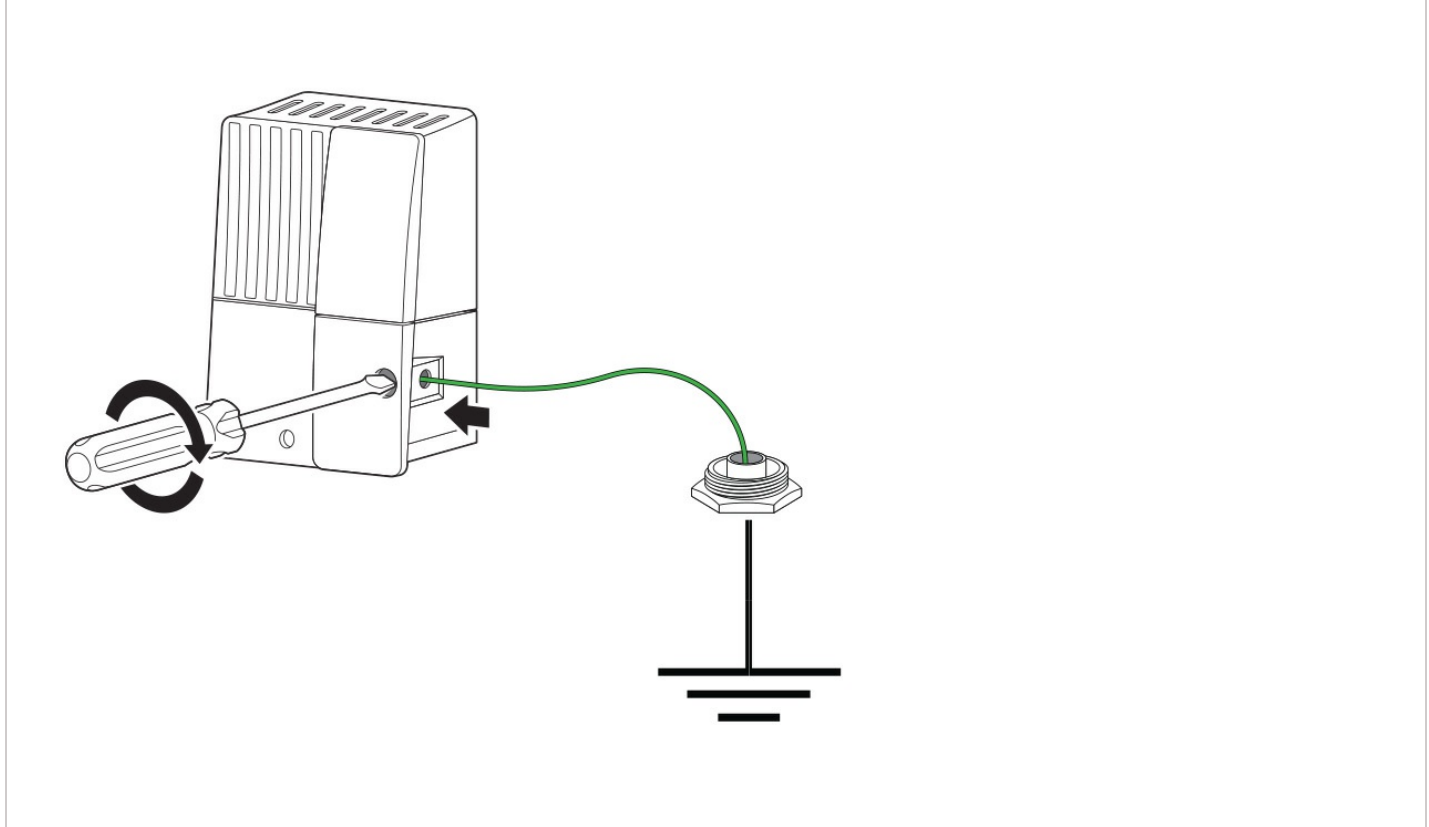

1. Insert copper wire from earth ground hardware, and tighten screw in front.
2. Minimum 10 AWG/5mm² wire to earth ground hardware.
3. Add copper-clad steel ground rods and/or plates sufficient to achieve 10Ω or less resistance at a minimum 8'/2.5 m away from controller.

HCC - Two Zones Simultaneously

The HCC controller has the ability to operate two Hunter valves at one time therefore, allows for more than one program to run at the same time. Only two programs can be allowed to run concurrently. This is a great feature if you have a short water window and the available water to feed multiple stations; however, it could become an issue if the flow of your irrigation system cannot support operating multiple stations at the same time. If you do not have the available water to operate multiple stations at one time, you will need to consider and calculate when each program will finish, or review the total watering time for each program.

Note: It is important to stagger the start times a few minutes apart so the programs will run concurrently. Programs with the exact same start time will result in running only one of the programs. See example below of two:

Start Times

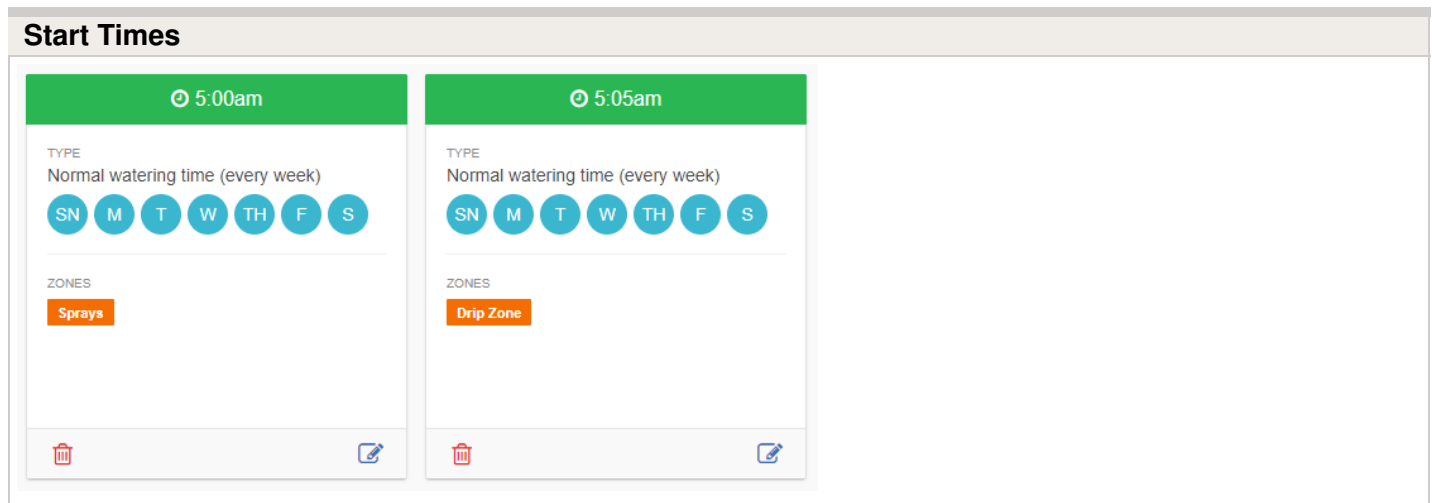

Start Time	Zone	Type	Schedule
5:00am	Sprays	Normal watering time (every week)	SN, M, T, W, TH, F, S
5:05am	Drip Zone	Normal watering time (every week)	SN, M, T, W, TH, F, S

Controller Screen

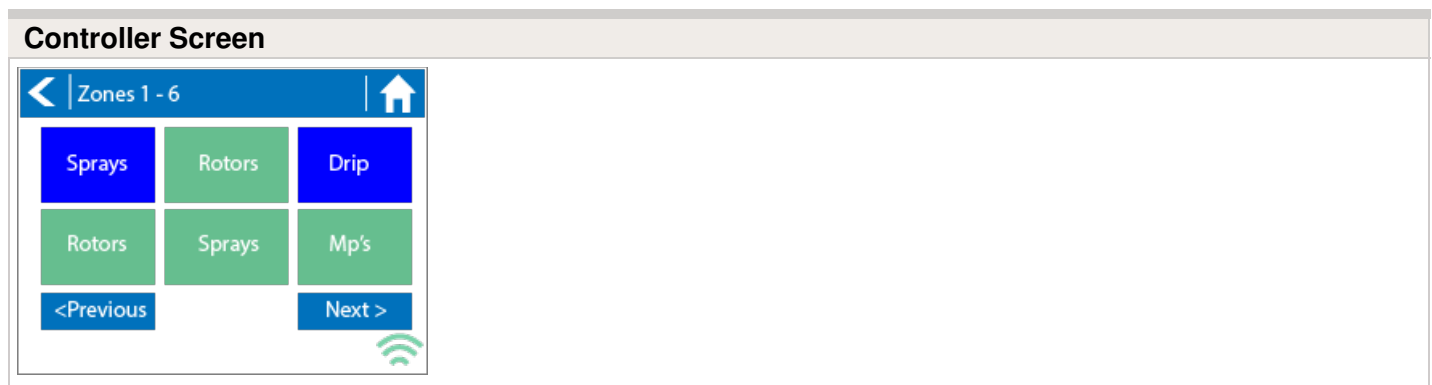

Controller Screen showing a grid of buttons for Sprays, Rotors, and Drip. The screen also displays '<Previous' and 'Next >' buttons, a home icon, and a Wi-Fi signal icon.

Lightning Transformers with Controllers

Hydrawise controllers are capable of operating lighting transformers equipped with the PXSUNC interface box. A commonly used transformer with the PXSUNC is the PX or EX Transformer. We also offer a DX Transformer that can be controlled from an irrigation controller via the 24 volt EXTERNAL connection built inside the controller.

Connect wires from the first **PXSUNC or external ports inside the DX** box to a station output number (and the Common) on the Hydrawise controller.

PRO-C with PX SYNC Example



Important Pump/Master Valve notes:

Controller	P/MV Terminal	Output
HC	If a pump or master valve is in use, the lighting transformer should not be used in conjunction with	Single station output will operate one at a time. Irrigation must not be programmed for duration of the

	irrigation controller.	lighting schedule.
PRO-HC	If a pump or master valve is in use, the lighting transformer should not be used in conjunction with irrigation controller.	Single station output will operate at a time. Irrigation must not be programmed for duration of the lighting schedule.
HPC	If using PUMP or master valve, this station output must be set to OFF in the programming.	Single station output will operate at a time. Irrigation must not be programmed for duration of the lighting schedule.
HCC	If using PUMP or master valve, this station output must be set to OFF in the programming.	Two station outputs will operate at a time. Any two programs will run simultaneously (lighting program and irrigation program).

HPC- WRCLIK and HC Flow Meter

In the event you will need to install a flow meter and a rain sensor on the **HPC** controller, please use the following instructions. The **HPC** controller utilizes a single SEN output so these steps are necessary to make this work. For correct field wiring of the flow meter, please reference the article [here](#).^[32]

NOTE: The software will only recognize the flow meter for this type of installation. The Wireless Rain Klik will still shut down system after a rain event, but this will not reflect

anywhere in the software. The reports will not show ANY data for the rain events.

IMPORTANT: You will see alerts for underflow from the flow meter since the system will continue to run even with the common circuit interrupted by the rain event. These alerts will have to be ignored for this type of application. For more details on alerts, please view this article [here](#). [33]

Please reference chart and illustration below for controller wiring details.

Illustration	Terminals	Wires
Figure 1.	AC 1/ AC 2	WRCLIK Yellow
Figure 2.	COMMON	WRCLIK White
Figure 3.	Valve Common	WRCLIK Blue
Figure 4.	Flow meter - Blue/White	METER Blue/White

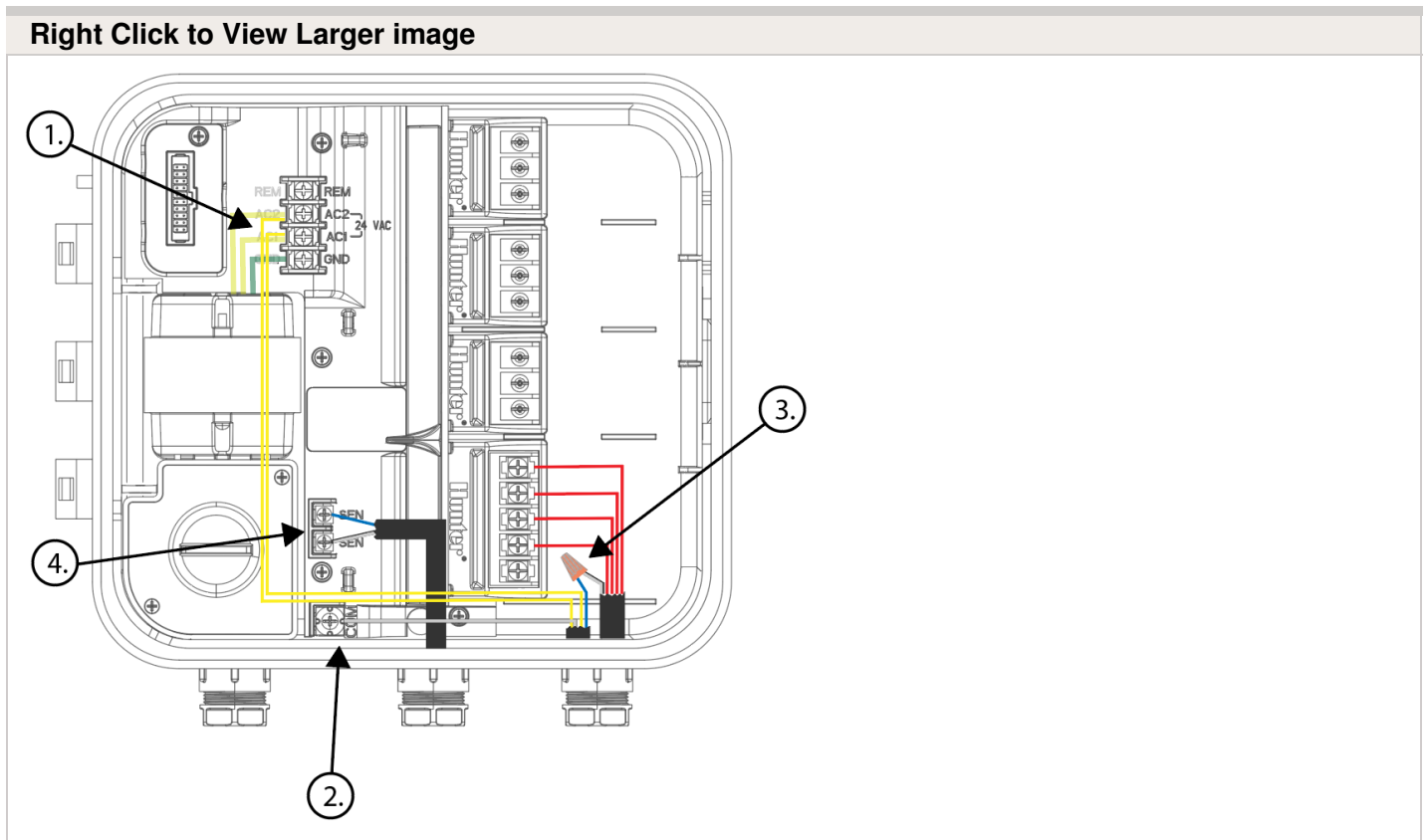

Flow Meter Pressure Loss Chart

HC FLOW METER PRESSURE LOSS CHART

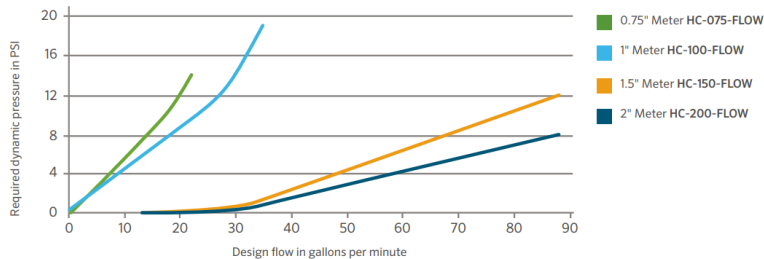

Flow Meter - Configuration

Assigning the Meter

Please view the steps and screenshots to access this feature:

1. Click on **"Sensors"** from the home dashboard.
2. Add **"Sensor."**
3. Choose a **name**, **sensor type**, and **controller input** (flow related only).
4. Choose which **zones** should be linked to the sensor.
5. Click **ok** when finished.

Step 1



IRRIGATION CONTRACTOR
WE WATER



Mr King - Belmont
IRRIGATION CONTRACTOR

- Home
- Zones & Schedules >
- Watering Triggers
- Sensors**
- Controller Settings
- Reports

Step 2

Sensors

Hydrawise supports standard rain sensors, soil moisture sensors and open/closed contact flow meters. 



Add Sensor to Controller

Step 3

Add Sensor ✕

Sensor details ▸ Set zones

Sensor Name

Assign a descriptive name for this sensor

Flow Meter

Type of Sensor

Choose the type of sensor you have installed. You can also create a custom sensor type if you have something non standard.

¼ inch NPT Flow Meter

Create New Sensor Type...

Controller Input

Choose the input on the controller that this sensor is wired to

SEN-1

Cancel < Prev Next > ✓ OK

Step 4

Add Sensor ✕

Sensor details ▸ Set zones

Select Zones

Select the zones which will use this sensor

Available zones	Selected zones
Carioca Court	Carioca Court
Back Grass	Front Grass
Back Drip	Street Drip
Diamond Street Controller	Front Drip
Front Grass	
Front Flowers	
Back Drip	

Cancel < Prev Next > ✓ OK

Flow Meter - Quick Start Guide

Please click on the link below to download the flow meter connection guide.

Flow Meter - Installation Tips

Flow meters are supplied with [detailed installation instructions](#) ^[30].

The flow meter wires need to be cabled back to the controller and connected to the **Sensor** inputs on the controller. See chart below for wiring standard Hydrawise flow meters (Sizes include 3/4", 1", 1.5", 2")

FLOW METER WIRE	SCREW TERMINAL	CONTROLLER
BLUE	SEN 1, 2	HC
BLUE	SEN 1, 2	PRO-HC
BLUE	SEN	HPC-FP
WHITE	COM	HC
WHITE	SEN COM	PRO-HC
WHITE	SEN	HPC-FP
RED	Not Used, Cap off	N/A

The tips below include all the necessary key points of the install to avoid any false alerts or readings.

Installation Steps	Description
	Flow meters are designed to be installed horizontally only , with the dial facing up. Not vertically. Analog dial for manual readings

Flow Meter Body	in U.S. are shown in US gallons (Int. customers the dial reads in Cubic Meters). Units can be changed in App to gallons or liters.															
Adapter	Brass unions included to fit your irrigation system.															
Entry Location	<p>Install between the master valve and zone valves. Meter should be installed 10 times pipe diameter before and 5 times after with straight pipe and no fittings. See example:</p> <table border="1"> <thead> <tr> <th>Pipe</th> <th>10x-Before</th> <th>5x-After</th> </tr> </thead> <tbody> <tr> <td>3/4"</td> <td>7.5"</td> <td>3.75"</td> </tr> <tr> <td>1"</td> <td>10"</td> <td>5"</td> </tr> <tr> <td>1.5"</td> <td>15"</td> <td>7.5"</td> </tr> <tr> <td>2"</td> <td>20"</td> <td>10"</td> </tr> </tbody> </table>	Pipe	10x-Before	5x-After	3/4"	7.5"	3.75"	1"	10"	5"	1.5"	15"	7.5"	2"	20"	10"
Pipe	10x-Before	5x-After														
3/4"	7.5"	3.75"														
1"	10"	5"														
1.5"	15"	7.5"														
2"	20"	10"														
Cable used (shielded cable only)	<p>18 gauge - 1000 foot max Length. Shielded direct burial cable must be used. Cable should consist of two dedicated wires and must not be in the same conduit, cable bundle or trench as the solenoid wires. DO NOT share common wire. Shielded cable is commonly available, here are some manufacturers (Paige ^[34] & Regency ^[35]) For additional information on avoiding electrical interference, see below:</p>															
Flow meter body	Arrow indicates direction of flow.															
Wire Connection	Blue/White wire only, red not used. See sensor configuration ^[36] for more info based on model controller.															
Log in to your account	Enter your login ^[13] information.															
Create your flow sensor	App will show options for all HC meters.															
Creating Alerts	See link here ^[37]															
Reading Meter	See link here ^[38]															
Testing Meter	See link here ^[39]															

Avoid Electrical Interference

- Always use shielded cable, between the controller and the HC Flow Meter.
- At the controller end, using the shield (foil wrap) and the bare wire connect them to the controller GND terminal (not required for HC controllers).
- Do not connect the other end of the Shield or the bare wire to the Earth or a grounding stake
- Use Waterproof wire connectors at the flow meter, such as the [3M-DBOB](#) [40].
- Shielded cable is commonly available, here are some manufacturers. [Paige](#) [34] & [Regency](#) [35]

In the event you continue to receive bad readings or false alerts, please contact us support@hydrawise.com [15]

Flow Meter - Specifications

HC FLOW METER SPECIFICATIONS



	HC-075-FLOW (¾")	HC-100-FLOW (1")	HC-150-FLOW (1½")	HC-200-FLOW (2")
	¾" NPT body,	1" NPT body, male	1½" NPT body,	2" NPT body, male

Inlet/outlet connection size	male thread with 1" NPT male adapter	thread with 1.5" NPT male adapter	male thread with 2" NPT male adapter	thread with 3" NPT male adapter
Meter internal diameter	3/4"	1"	1.5"	2"
Minimum flow (GPM)	0.22	0.3	0.88	1.98
Maximum recommended flow (GPM)	15	30	66	105
Maximum flow rate (GPM)	21	34	88	132
Dial reading (US gal)	1 pulse per 0.1 U.S. gal	1 pulse per 1 U.S. gal	1 pulse per 1 U.S. gal	1 pulse per 1 U.S. gal
Maximum working pressure (PSI)	230	230	230	230

Flow Meter - Reading Meter

The Hydrowise flow meters come in a US Gallon reading for domestic and metric reading called M³ (Meters Cubed 1000 Liters) for international. Conversion rate for metric meters is 3.78 Liters to 1 US Gallon if required.

See example of meter reading below in US gallons:

Fig. 1	X100	8100 Gallons
Fig. 2	X10	814X.XX Gallons
Fig. 3	X1	8142.XX Gallons
Fig. 4	X0.1	8142.4X Gallons
Fig. 5	X0.01	8142.46 Gallons Total
Fig. 6	Size meter	1"
Fig. 7	Flow Indicator	Wheel spins when water is flowing.

We have a flow that has gone through the meter of 8,142.46 gallons.

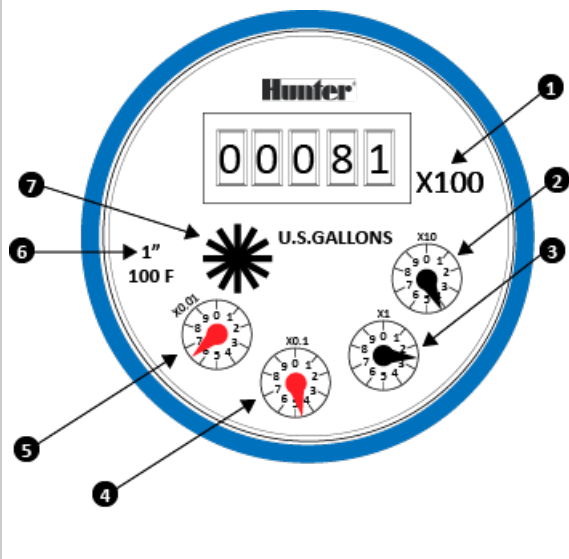

See example of meter reading below in Litres:

Fig. 1	8,000 Litres
Fig. 2	8,200 Litres
Fig. 3	8,220 Litres
Fig. 4	8,224 Litres
Fig. 5	8,224.7 Litres Total
Fig. 6	Wheel spins when water is flowing.

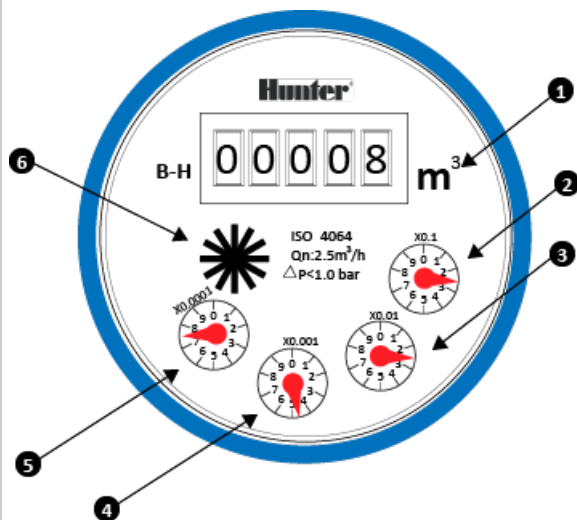

So we have a flow that has gone through the meter of 8,224.7 Litres. To calculate this into Gallons is easy $8,224.7 / 3.78 = 2175.84$ gallons.

Flow Meter - Testing Meter

If your flow meter is working but is not recording data in your **Dashboard** or events, follow the steps here:

1. Make sure sensor is configured ^[41] in the software.
2. Make sure controller is online. If not, please use link ^[42] for Wi-Fi troubleshooting steps.
3. Remove the wire splices at the flow meter connection in the field. Tap the two wires together that run to the controller 10 times, as each contact will record a pulse. Refresh the app to see if the flow usage was registered.
4. If app registered flow usage, your wiring and system are set up correctly. Reconnect to the flow meter and run a large flow (lots of sprinklers) zone. Did you get a flow on your app? If **YES**, all is OK. If **NO**, contact support@hydrawise.com ^[43].
5. If app did not register flow usage, test the sensor inputs on the controller. You can use the same method with a paper clip or wire to make contact between sensor 1 or 2 and the common terminal. Do this 10 times and then check for flow data usage at the home screen. If **YES**, there is a problem with the wire running to the flow meter. If **NO**, contact support@hydrawise.com ^[43].

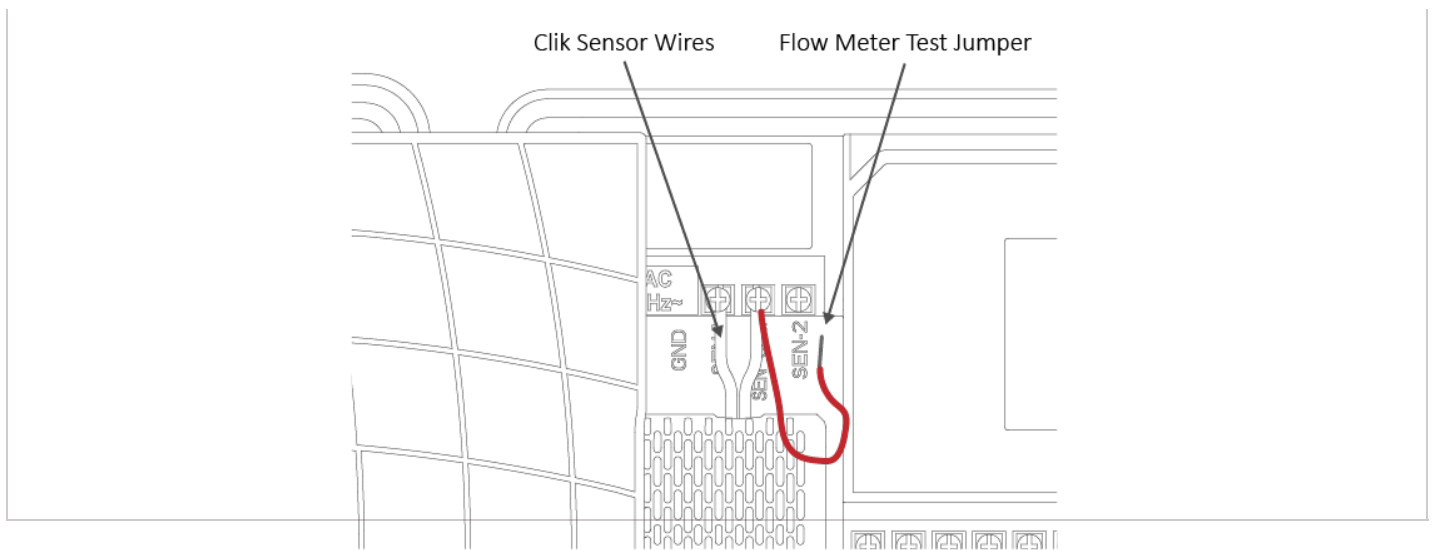

IMPORTANT: Our controller is not polarity sensitive. There is no risk of electric shock when performing these tests. However, if you feel uncomfortable, please contact a qualified technician or irrigation specialist for further assistance.

NOTE: If it works at the controller end but not the flow-meter end, there is a wiring fault.

If it doesn't work at the controller end, contact support@hydrawise.com [43].

If it works at both ends, but still does not register flow on the app, contact support@hydrawise.com [43].

Flow Meter - Custom Flow Sensor Configuration

To add a custom flow sensor, go to [Sensors](#) [44] from your web browser or smartphone application.

1. Click **Add Custom Sensor Type**

STEP 1

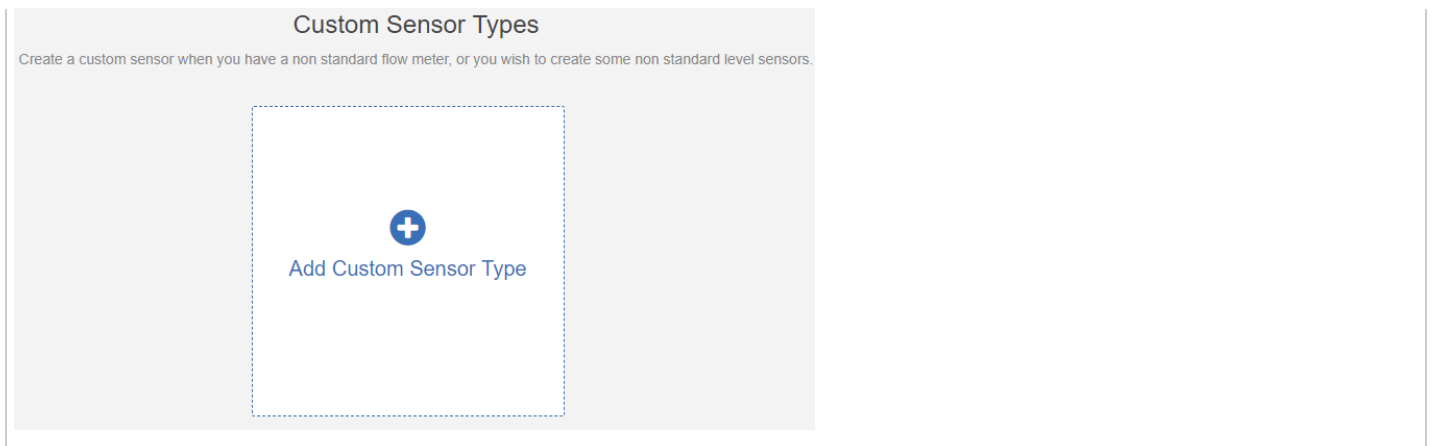

A dialogue box will appear for you to enter your custom flow meter details. Make sure you enter the calibration details for your custom pulse-based flow meter. Please refer to the manufacturer specifications to find out the calibration. Otherwise, you will not get accurate readings to display on your flow data.

NOTE: For our system to detect the correct flow data and reflect it on your **Dashboard** reports, any third-party flow meter used must be a true pulse flow meter or have a reed switch. We aim for a minimum of 10 pulses per min and a maximum of 120 pulses per min. That means if the flow rate was 10 gal per min, 1 pulse per gallon needs to be set.

When using a third-party flow meter, please ensure it meets the specs above and is calibrated correctly. Otherwise, data will not reflect accurately in reports. Also, note that the

wiring is not polarity sensitive. As long as you have one wire in a **Sensor Port** and a **Sensor Common**, the device will work correctly. For flow meters that use three wires and meet the specs above, configure the wiring until you find the two correct wires to use.

Single Flow Meter - Sharing Two Controllers

For this installation, we suggest a few tips to make sure you do not receive any unnecessary alerts.

When using multiple controllers on the same flow meter, there are two alerts we do not recommend using.

1. **High Flow Leak** - High water usage with no zones running.
2. **Slow Leak** - Water usage over last hour with no zones running.

These alerts are controller specific so when the controller with the flow meter is not in operation, it does know about the other controller operation.

Tips:

1. The inter station delay ^[45] should be set for 10-30 seconds. We do not recommend any higher.
2. Change the gallons in the alert to be higher (e.g. alert from 5 gallons to 20 gallons).

Following these parameters should allow the system to run normal when using one flow meter with multiple controllers.

Flow Meter - Winterization

We recommend that a qualified licensed contractor perform this type of winterization method. The blowout method utilizes an air compressor with a cubic foot per minute (CFM) rating of 80-100 for any mainline of 2" or less. The compressor is attached to the mainline via a quick coupler, hose bib, or other type connection, which is located beyond the backflow device. Compressed air should not be blown through any backflow or flow meter device. For additional winterization procedures, we highly recommend contacting the local dealer for the most common local practices. In the event you need to blow upstream from where the flow meter is located, we recommend bypassing the meter by temporarily using one of two options.

1. Installing a SCH 80 or galvanized nipple. See the size chart below:

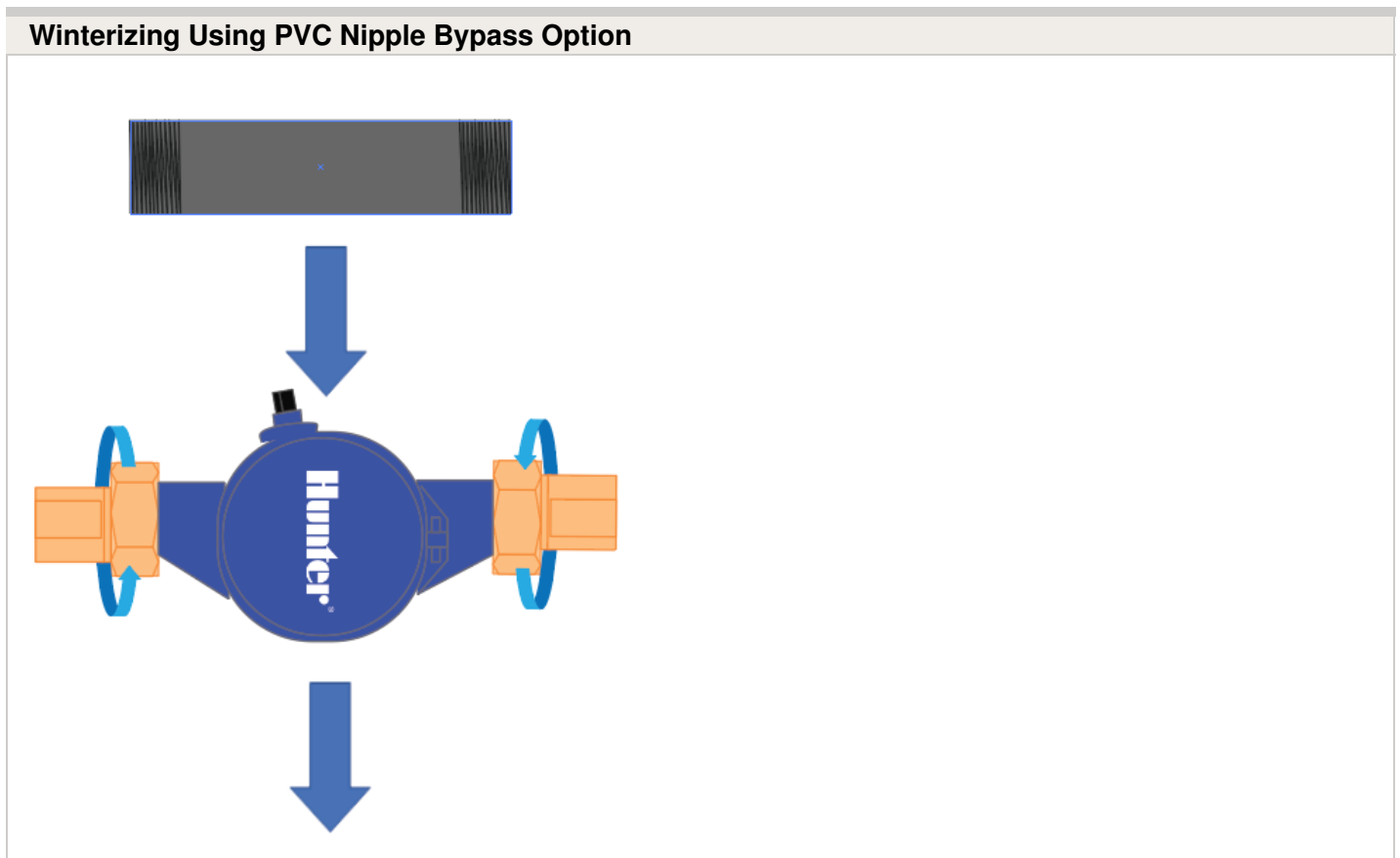

Model	Description	Male-Thread NPT	Nipple Length
-------	-------------	--------------------	---------------

HC-075-FLOW	3/4" NPT body, male thread with 1" NPT male adapter	1" NPT	5"
HC-100-FLOW	1" NPT body, male thread with 1.5" NPT male adapter	1 1/4"NPT	5"
HC-150-FLOW	1 1/2" NPT body, male thread with 2" NPT male adapter	2"NPT	11 3/4"
HC-200-FLOW	2" NPT body, male thread with 3" NPT male adapter	2 1/2"BSP	11 3/4"

2. A second option would be to install PVC tee diverters but this is done more efficiently during NEW installation.

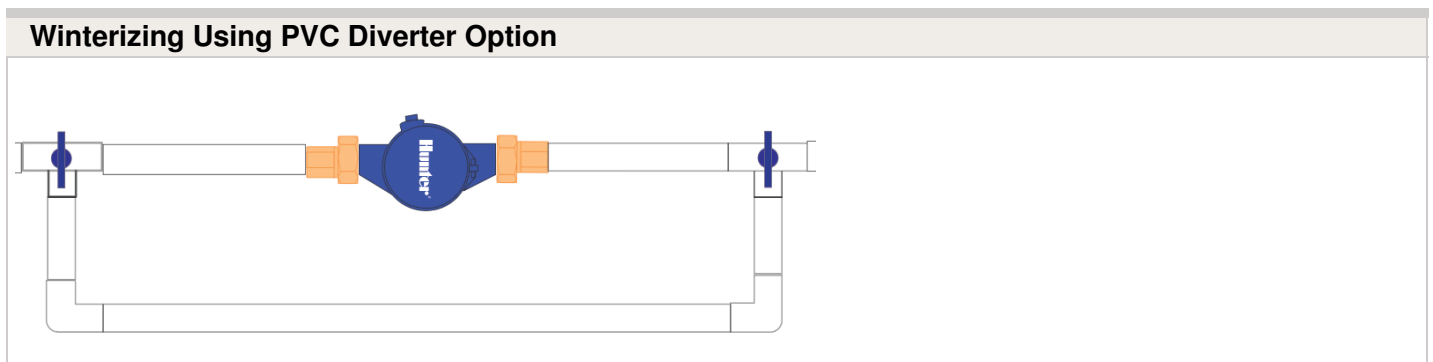

Find a Hunter Distributor closest to you using our interactive lookup - [Get Hunter](#) ^[46]

Pump Start Relay Wiring and Online Setup

In this article, we will discuss the following topics:

- Summary
- Operation Chart
- Wiring (24 VAC)
- Wiring to Power Source
- Online Setup
- Pump Start Relay Operation per Zone

Summary

When a system requires the use of a booster pump or pulls water directly from a creek or pond, it's imperative to include a relay to activate the pump each and every time. A pump start relay is a relay box that activates a pump every time a zone is activated from the controller. Zone valves are the individual valves that operate a group of sprinklers or drip emitters. Hydrowise controllers support 6- to 54-zone valves, depending on the model. Typically, one zone valve is turned on at a time and controls the irrigation in a specific area of your landscape. Whenever one of the irrigation zone valves is told to open by the controller, the controller also signals the pump start relay to turn the pump on.

Operation Chart

Controller Model	Set Pump Operation
HC	ON or OFF by All Zones
PRO-HC	ON or OFF by All Zones
HPC	ON or OFF by Zone or All Zones
HCC	ON or OFF by Zone or All Zones

Wiring (24 VAC)

Use a minimum distance of 15' (4.5 m) between the controller and the relay to dampen electromagnetic noise. In addition to this recommendation, Hunter also recommends all

controllers be mounted 15' (4.5 m) away from pumps and high-voltage devices.

1. Detach the pump start relay cover plate by removing the four screws with Phillips screwdriver.
2. Run a single wire from the "common" terminal on the controller to one of the yellow wires on the pump start relay.
3. Run a single wire from the "P/MV" terminal on the controller to the other yellow wire on the pump start relay.
4. Use wire nuts to make the connections and verify they are secure.
5. Install pump start relay cover plate and four screws. Close and lock the cabinet door.
6. Route wire through the conduit or one of the openings on the bottom of the cabinet.
7. Strip ½" (13 mm) of insulation from the ends of all wires. Secure the valve common wire to "**COM**" (Common) terminal. Attach the opposite control wire to the M/V terminal.

Pump Start Relay Maximum Wire Lengths						
MAXIMUM one-way wire length (do not go this far!)						
Model	18 AWG	16 AWG	14 AWG	12 AWG	10 AWG	8 AWG
PSR-22	243 ft	386 ft	616 ft	976 ft	1,551 ft	2,463 ft
PSR-52	134 ft	214 ft	341 ft	540 ft	859 ft	1,365 ft
PSR-53	134 ft	214 ft	341 ft	540 ft	859 ft	1,365 ft

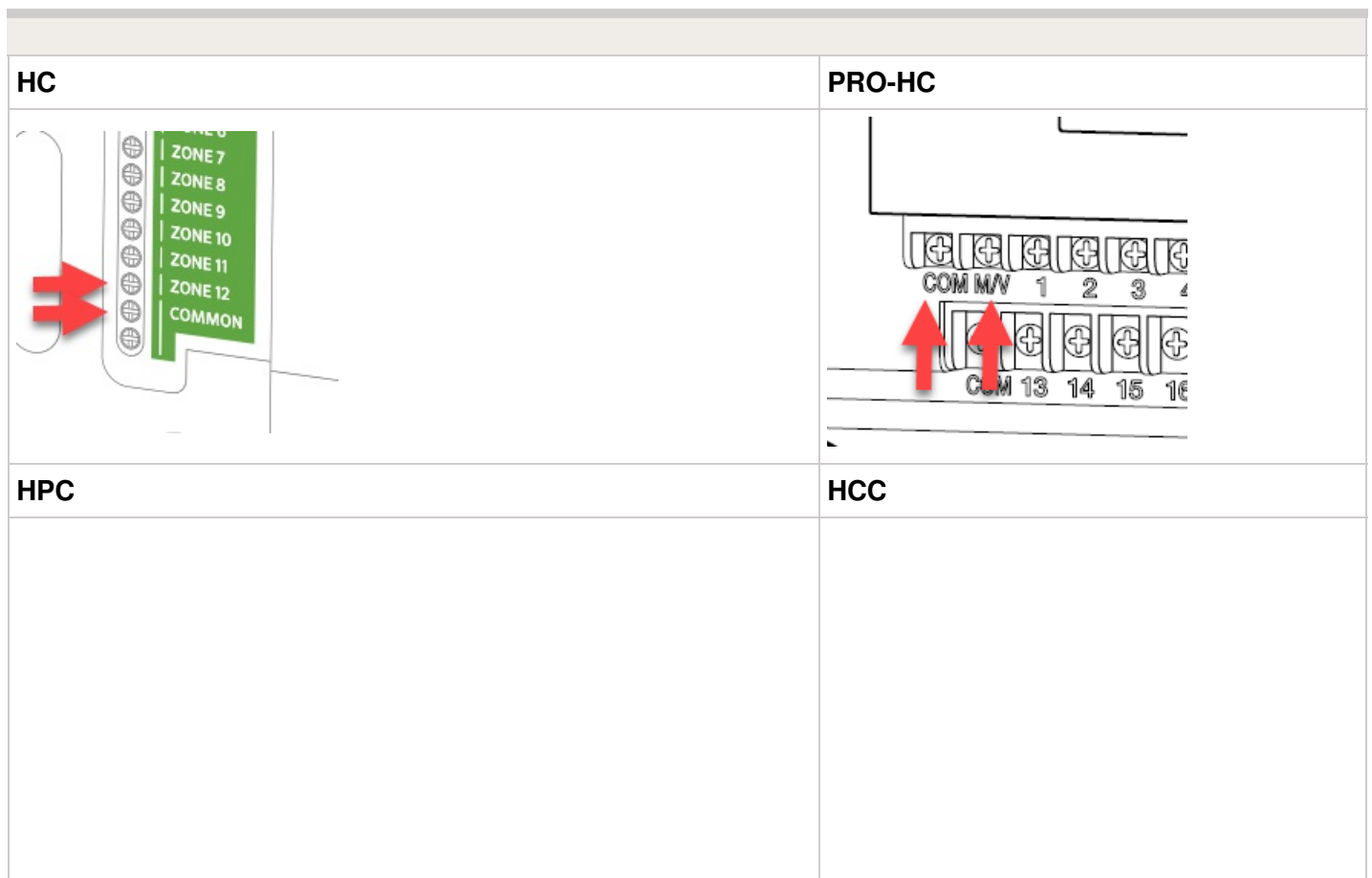

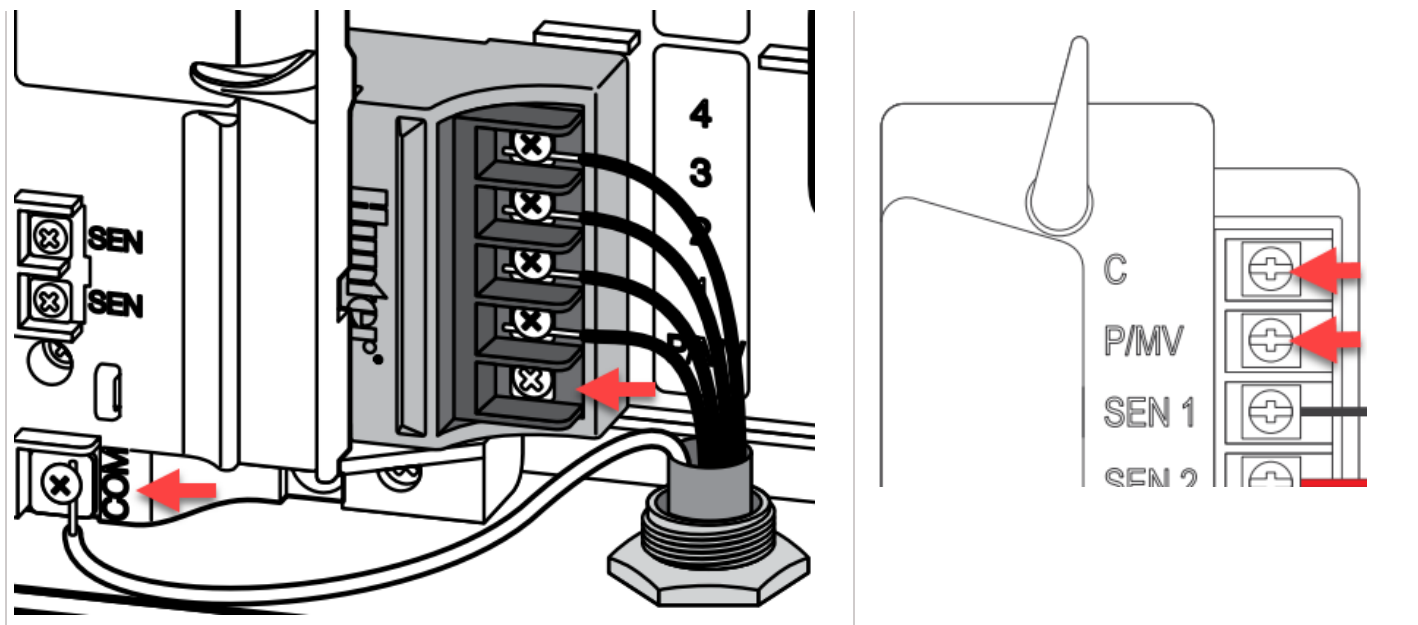

Note: With an HC Hydramatic controller, any one of your 6 or 12 zones can be configured to act as the pump start relay. We usually recommend wiring to the last zone that is not being used in the controller.

Wiring to Power Source

NOTE: Connecting the pump start relay should only be done by a licensed electrician following local codes. Improper installation could result in shock or fire hazard.

1. To prevent electric shock, turn the main circuit-breaker switch to “off” prior to making electrical connections.
2. Assemble conduit piping and connect AC power from the power source to one side (LINE IN) of the relay.
3. Assemble conduit piping and connect wiring from the pump motor to the other side of the relay (LOAD OUT).
4. Check to make sure there are no exposed or loose connections.

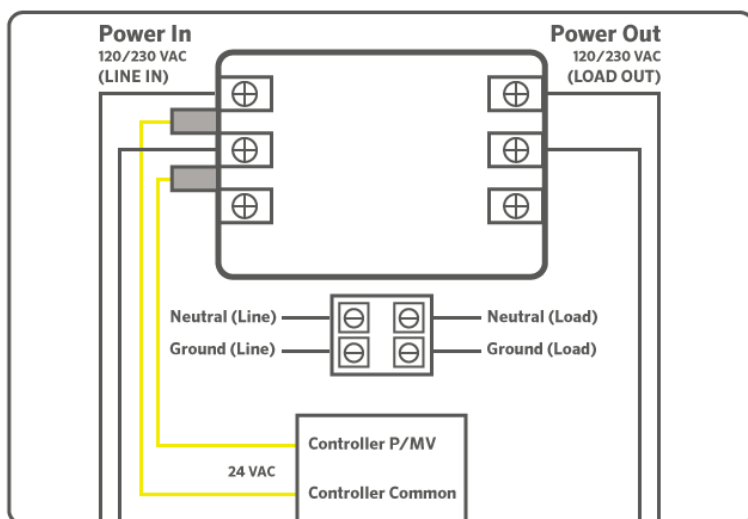

Online Setup

This setup option is prompted when you first go through the initial setup wizard in the software.

The online instructions will refer to a **master valve** but this same setting applies when using a **pump start relay**.

Note: With an HC Hydrawise controller, any one of your 6 or 12 zones can be configured to act as the pump start relay. We usually recommend wiring to the last zone that is not being used in the controller.

Does your irrigation system have a master valve?

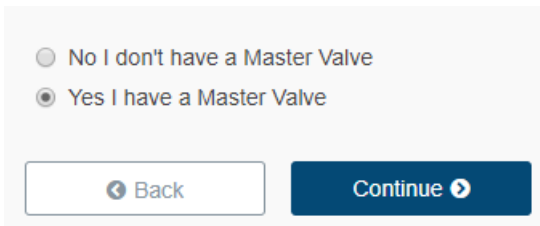

No I don't have a Master Valve
 Yes I have a Master Valve

[← Back](#) [Continue →](#)

If you need to change this in the software after the setup wizard, refer to the instructions below.

1. Log in to your Hydrawise account
2. Click on **Zones and Schedules** for the PC or **Zones** if using the mobile app.
3. Choose **YES** from the drop-down menu above the zones. If you have an HC controller, choose the zone number to which you have the master valve wired.

HC Controller	PRO-HC, HPC, and HCC Controllers

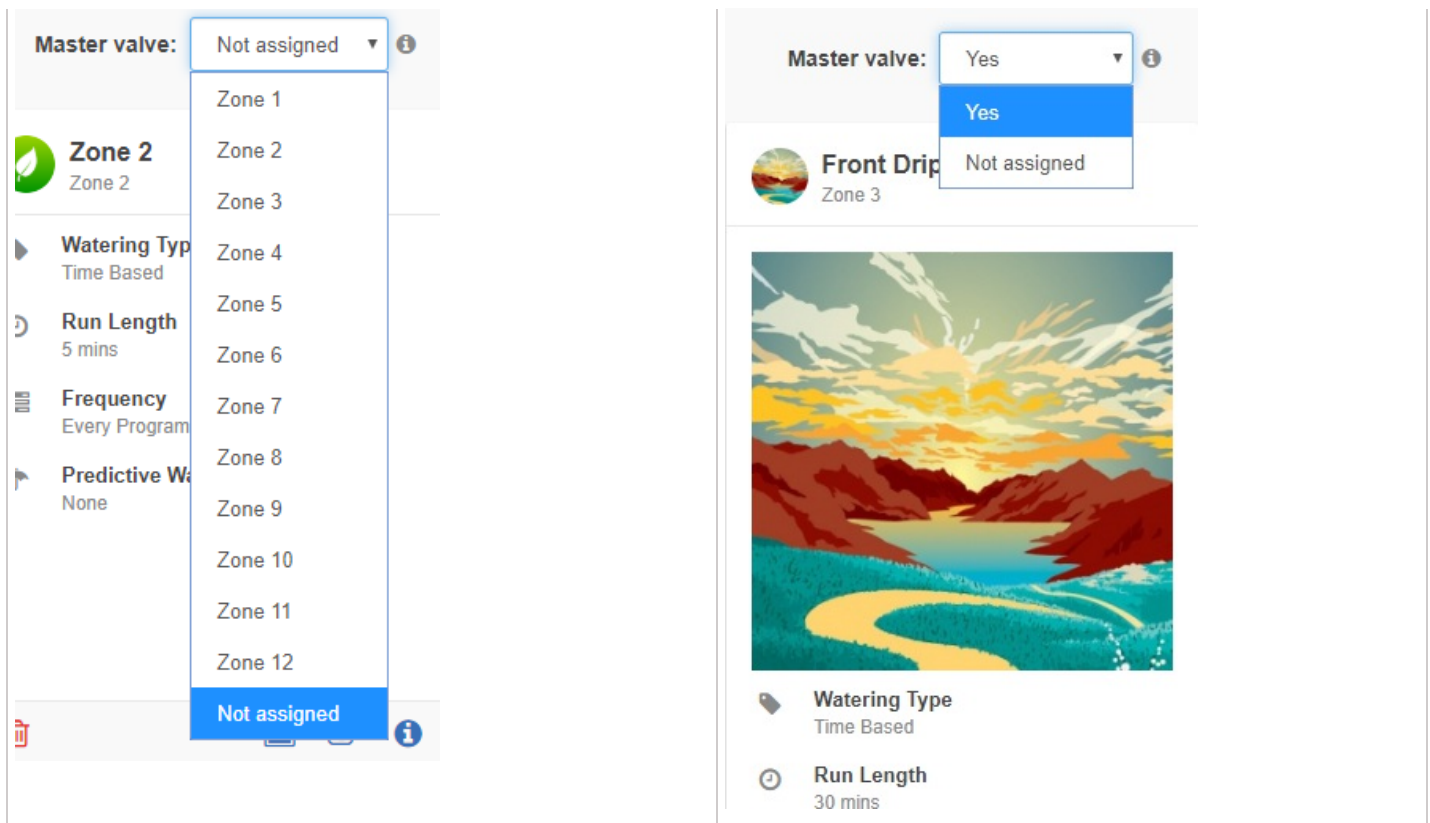

Pump Start Relay Operation per Station

When selecting a **pump start relay** to be on/off for an individual zone, you can edit the zone in **Zones and Schedules** under **Advanced Settings**. This option is useful when one zone is using city water and another is using water from a different source.

Note: This option is for HPC and HCC controllers only.

Follow the steps below to change this setting:

1. From the **Zones and Schedules** page, click on the  icon on the zone you would like to edit.
2. Click on **Advanced**, which is located on the top blue search section.
3. Select **Use Global Master Valve Setting** to keep this circuit on or select **Disable Master Valve** to turn it off.

Master valve

Use Global Master Valve Setting Disable Master Valve

Water Adjustment

Fine tune your watering if your zone appears to be too dry or wet



Master Valve Wiring and Online Setup

In this article, we will discuss the following topics:

- Brief Summary
- Operation Chart
- Wiring
- Setup Online
- Master Valve (P/MV) Operation per zone

Brief Summary

A master valve is a normally closed valve installed at the supply point of the main line that opens only when the automatic system is activated. Zone valves are the individual valves that operate a group of sprinklers or drip emitters. Hydrowise controllers support 6 - 54 zone valves, depending on the model. Typically one zone valve is turned on at a time and controls the irrigation in a specific area of your garden. Whenever one of the irrigation zone valves is told to open by the controller, the controller also signals the master valve to open. The purpose of the master valve is to shut off the water to the irrigation system when none of the zone valves are operating.

Operation Chart

Controller Model	Set Master Valve Operation
HC	ON or OFF by All Zones

PRO-HC	ON or OFF by All Zones
HPC	ON or OFF by Zone or All Zones
HCC	ON or OFF by Zone or All Zones

Wiring

1. Route the master valve wire between valve location and Hydrowse controller.
2. Attach the common wire to either solenoid wire. This is most commonly a white colored wire. Attach a separate control wire to the remaining wire of each master valve solenoid. All wire splice connections should be done using waterproof connectors.
3. Route wire through the conduit or one of the openings on the bottom of the cabinet.
4. Strip 1/2" (13 mm) of insulation from ends of all wires. Secure the valve common wire to "COM" (Common) terminal. Attach the opposite control wire to the M/V terminal.

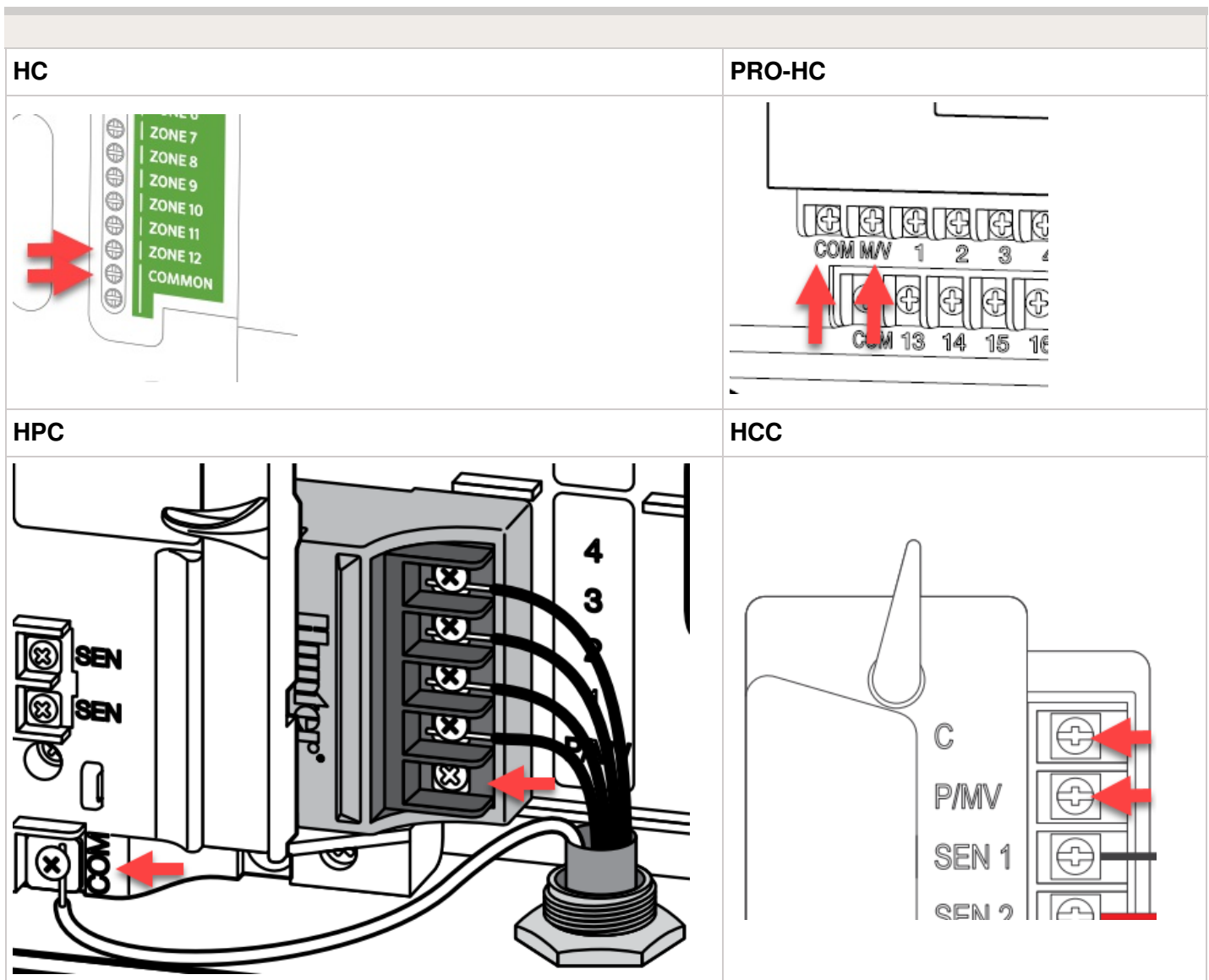

Note: With a HC Hydrawise controller, any one of your 6 or 12 zones can be configured to act as a master valve. We usually recommend wiring to the last zone not used in the controller.

Setup Online

This setup option is prompted when you first go through the initial setup wizard in the software.

Does your irrigation system have a Master Valve?

No I don't have a Master Valve

Yes I have a Master Valve

In the event you need to change this in the software after the setup wizard, please refer to the instructions below.

1. Login to your Hydrawise account
2. Click on **Zones and Schedules** for the PC or **Zones** if using the mobile app.
3. Choose **YES** from the drop down above the zones. If you have an HC controller, then you choose the zone number that you have the master valve wired too.

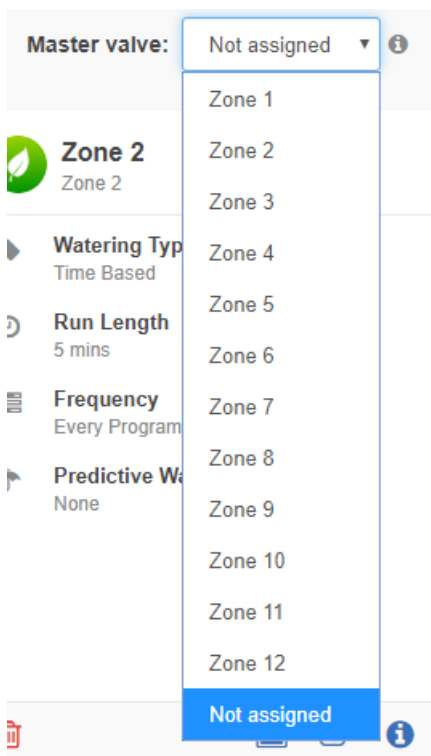
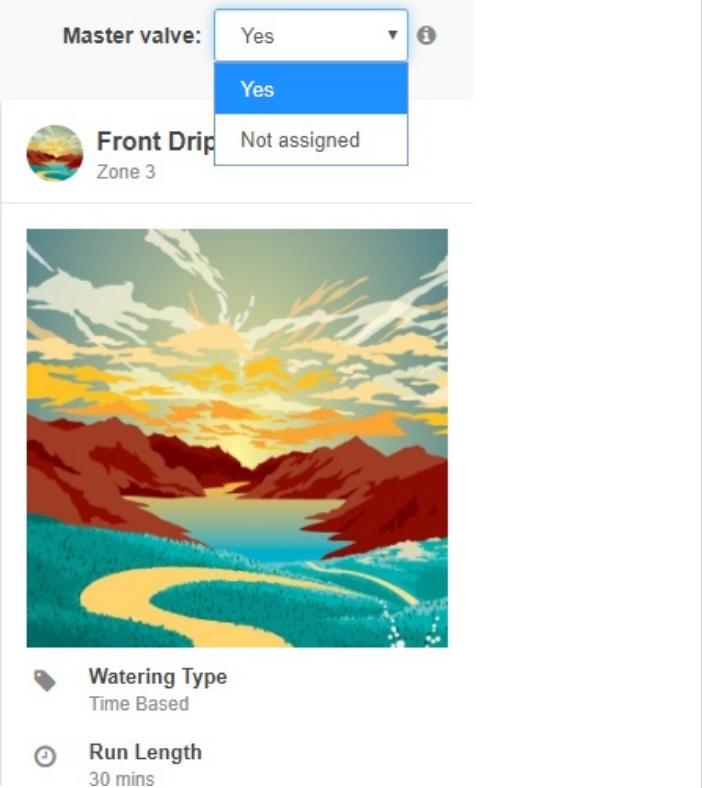
HC Controller	PRO-HC, HPC, and HCC Controllers
	

Master Valve (P/MV) Operation per Station

For selecting a master valve to be on/off for a individual zone, this can be done when editing the zone in zones and schedules under advanced settings. This option is useful when one zone is using city water and another is using from another source.

Note: This option is for HPC and HCC controllers only.

Please follow the steps below to change this setting.

1. From the **Zones and Schedules** page, click on the  icon on the zone you would like to edit.
2. Click on **Advanced** located on the top blue search section.
3. Select Use **Global Master Valve Setting** to keep this circuit on or select **Disable Master Valve** to turn this circuit off.

Master valve

Use Global Master Valve Setting Disable Master Valve

Water Adjustment

Fine tune your watering if your zone appears to be too dry or wet



Valve - Wire Distance

Below is a chart indicating the maximum wire run between the controller and the Hunter AC

solenoid valves.

Valve Wire Sizing (Feet)							
Ground	Control Wire						
	18	16	14	12	10	8	6
18	850	1040	1210	1350	1460	1540	1590
16	1040	1340	1650	1920	2150	2330	2440
14	1210	1650	2150	2630	3080	3450	3700
12	1350	1920	2630	3390	4170	4880	5400
10	1460	2150	3080	4170	5400	6670	7650
8	1540	2330	3450	4880	6670	8700	10530
6	1590	2440	3700	54000	7690	10530	13330

Notes:

Maximum one-way distance in feet between controller and valve heavy-duty solenoid: 24 VAC, 350 mA inrush current, 190 mA holding current, 60 Hz; 370 mA inrush current, 210 mA holding current, 50 Hz

Valve Wire Sizing (Metric)						
Ground	Control Wire					
	0.5	1	1.5	2.5	4	6
0.5	140	190	210	235	250	260
1.0	190	290	335	415	465	495
1.5	208	335	397	515	595	647
2.5	235	415	515	730	900	1030
4.0	250	465	595	900	1175	1405
6.0	260	495	647	1030	1405	1745

Notes:

Maximum one-way distance in meters between controller and valve Heavy-duty solenoid: 24 VAC, 350 mA inrush current, 190 mA holding current, 60 Hz; 370 mA inrush current, 210 mA holding current, 50 Hz

