



**Ambient light powered,  
smart irrigation controller**

**LEIT1 ILV-075  
LEIT1 ILV-100  
LEIT1 ILV-150  
LEIT1 ILV-200**



**I N S T R U C T I O N M A N U A L**

## TABLE OF CONTENTS

INTRODUCTION .....	3
1. About the controllers .....	3
2. Component identification .....	4
3. System components .....	5
4. Valve installation .....	6
5. Programming .....	8
6. Setting time and date .....	8
7. Setting watering day schedules .....	10
8. Setting watering start time .....	12
9. Setting watering run times .....	14
10. Setting the SimpleSmart™ option .....	15
11. Setting seasonal adjustment (monthly budget) .....	18
12. Rain delay setting .....	19
13. Events off setting .....	20
14. Manual watering .....	21
15. Connecting a rain sensor .....	22
16. Maintenance, troubleshooting and repairs .....	24
17. Warranty .....	26
18. Technical assistance .....	27

Thank you for purchasing DIG's LEIT-1™ ambient light powered irrigation controller.

## **1. ABOUT THE CONTROLLERS**

The LEIT-1™ is a one-station, ambient light (solar) powered smart controller that uses a patented energy management system to power the controller day and night. The controller requires no batteries, AC power or direct sunlight and can be installed above grade anywhere in the landscape.

The controller employs the latest in water conservation features and can be pre-set to automatically adjust the watering durations according to regional seasonal changes.

## 2. COMPONENT IDENTIFICATION

1. Solar PVM
2. LCD screen
3. 7 button keypad
4. Rain sensor connection
5. Quick reference label
6. Collapsible solenoid wire
7. Manual flow control
8. DC Solenoid

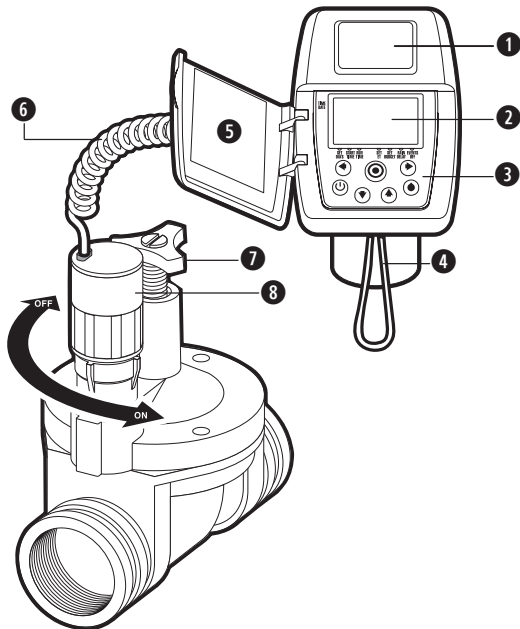

### 3. SYSTEM COMPONENTS

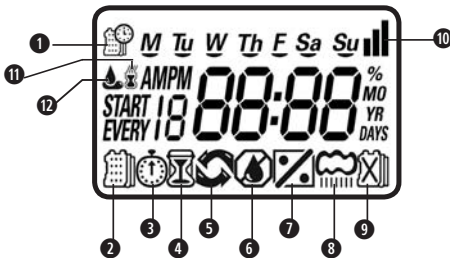

#### LCD Display

1. **Time and Date** - Indicates current time and day
2. **Set Watering Days** - Choose either specific days, odd/even days, or up to once every 30 days
3. **Start Time** - Up to 5 start times per day available
4. **Run Time** - Watering duration from 1 minute to 6 hours
5. **Manual Run** - Appears when manual button is pushed
6. **Set ET** - Used to set one of the 20 SimpleSmart™ presets
7. **Set Monthly Budget** - Seasonal adjustment setting (0%-200%) in 5% increments or to fine-tune SimpleSmart™ programming
8. **Rain Delay** - Delay irrigation setting from 1>99 days with automatic restart
9. **Events Off** - Suspends watering for any month or any specific day within the month.
10. **Power Level** - Represents current charge level
11. **Sensor** - Appears only when sensor is connected and active
12. **Watering** - Appears when valve is open

## Control Buttons



Select programming mode



Turn ON/OFF program



Start/stop a manual cycle



Move left/right to select a value



Raise/lower the selected value

## 4. VALVE INSTALLATION

The LEIT-1™ controller is designed for the automation of drip and sprinkler systems. The LEIT-1™ controller with valve features female-threaded inlet and outlet. The LEIT-1™ is generally installed above the ground to allow the controller to power itself using light.

Maximum static pressure: 150 PSI (10.3 BAR)

**NOTE:** *Wrap all fittings with Teflon tape.*

**Do not use pipe cement on the valve as this will damage the valve and void the warranty.**

Thread inlet, outlet fittings and pipe into the valve with swivel fitting or a union. Make sure when wrapping fittings with Teflon tape that no excess gets into the internal assembly. Tighten the fittings with a wrench, but do not over tighten.

**NOTE:** *Additional control valves must **not** be installed downstream of the valve.*

Consult local codes for specific details.

1. Flush main line until water runs clear before installation.
2. Shut off main water supply.
3. Install the LEIT-1™ with in-line valve directly to the main line and above the ground. The arrow on the valve body indicates direction of water flow and the solenoids with the controller should be on the downstream side of the valve.

4. Turn the main water supply on and pressurize the system; the valve may discharge water momentarily and then shut off.
5. The valve features manual bleed that can be used via the solenoid, which enables the valve to be operated without the use of the LEIT-1™.



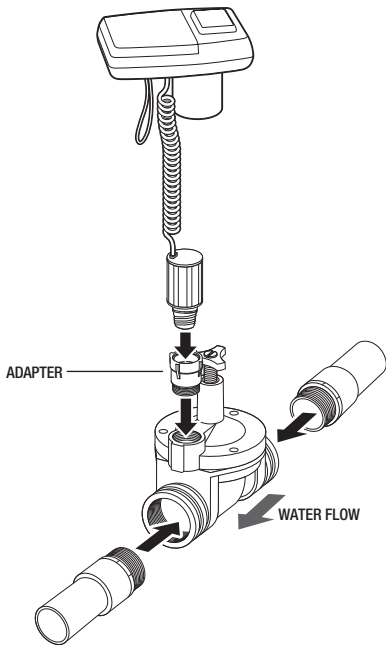

To turn the valve on via the solenoid, lift the LEIT-1™ controller from the solenoid and turn the solenoid counter clockwise  $\frac{1}{2}$  to  $\frac{3}{4}$  of a turn, or until you hear or see water flowing through the valve. To turn the water off, turn the solenoid clockwise  $\frac{1}{2}$  to  $\frac{3}{4}$  of a turn and wait for a few seconds for the valve to close.

6. Program the LEIT-1™ controller (see section 5).



## 5. PROGRAMMING

In order to program the LEIT-1™, you must first let the unit sit out in the light to charge. In bright light conditions (full sun) this will take under 30 minutes. In shaded conditions this could take up to 2 hours.

This section explains the programming features, and the steps necessary to assign irrigation schedules. To program the controller use the  to select the desired programming mode, the  to make the entry flash and the   buttons to change the value.

**NOTE:** Only a flashing value can be changed.

**NOTE:** If the last data entered stops blinking, press  again to resume programming and repeat the steps.

## 6. SETTING TIME AND DATE



The controller can display the time in either a 12 or 24 hour format. To change the time format, from the home screen:

1. Press and hold the  button for three seconds until the display switches format (AM/PM disappears).









### SETTING THE CURRENT TIME AND DATE

**To enable the controller to operate properly, the current time and date must be set.**

1. Press the  button, until the  icon appears along with the time and the day of the week.





2. If the current time has not been set and needs to be updated press  and the hour digit starts blinking.
3. To set the current hour, press  or  (note AM and PM designations).
4. To set the minutes, press  again and the minute digit starts blinking. Press the  or  to set the current time in minutes.



5. Repeat the steps to set the current date including, month, day and year. When the date is selected and updated, the day of the week will be update at the same time to correspond with the date.

MONTH DAY YEAR



6. Press  to proceed to the next step SET DAYS  or review the program.

Press  to move backward.

## 7. SETTING WATERING DAY SCHEDULES







### Option 1 - Setting Specific Days of the Week:

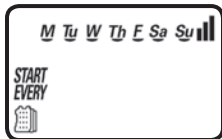

This setting determines which days the LEIT-1™ controller will operate. Choose either watering on specific days of the week, EVEN/ODD days or cyclical from daily up to once every 30 days. The controller's default setting is to water on all specific days of the week.

For example, if you want to water every Tuesday, Thursday and Sunday:

1. Press the  button until the  icon and the days of the week appear on the screen.



2. Press  once and **M** (for Monday) starts blinking.
3. Press,  and underscore under **M** (Monday) disappears. Monday is de-selected.
4. Press  twice and **W** (for Wednesday) starts blinking.
5. Press  and the underscore under **W** (Wednesday) disappears. Wednesday is de-selected.
6. Press  twice and **F** (Friday) starts blinking.
7. Press  and the underscore under **F** (Friday) disappears. Friday is de-selected.

- Press  and the underscore under **Sa** (Saturday) starts blinking.
- Press  and the underscore under **Sa** disappears. Saturday is de-selected.

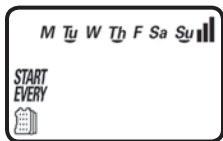







- Press the  button to proceed to the next step or to set even/odd days.

### Option 2 - Setting Even or Odd Days:

To select **EVEN** days, **ODD** days or cyclical days from one day up to every 30 days refer to the following example.

**Example: setting the controller to water every 10 days:**

- Press the  button until the  icon and the days of the week appear.
- Press  and  to skip all the days of the week (underscore must be removed beneath all days).
- Press  and **EVEN** appears blinking. (To select **ODD** days press )



- Press  again and 1 DAY appears blinking. To select the number of days between watering of 10 days, press  until 10 appears on the display.



5. To return to a weekly schedule, Press and the program returns to the weekly schedule for selecting the day of the week.
6. Press the button to proceed to the next step START TIME or to review the program.

## 8. SETTING WATERING START TIME

The LEIT-1™ smart controller can have up to five separate irrigation start times per day.

To set a start time,

1. Press the button until the icon appears. START 1, displays OFF or the last start time programmed in START 1 appears.

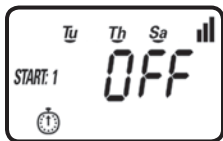



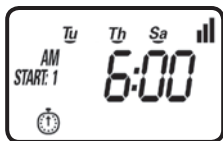

2. Press and OFF (or the first start time programmed) begins blinking.
3. To set the desired first start time hour (note AM and PM designations), press or .
4. Press and the minutes start blinking.
5. Press or and set the desired start time minutes.

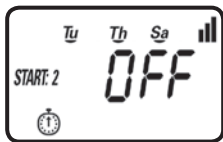

6. Press  again, the second start time and OFF (or the last start time programmed) appear blinking.



7. To set the desired second start time hour (note AM and PM designations), press  or .
8. Press  again and the minutes begin blinking, press  or  to select the watering start time in minutes. Repeat the steps to set the third and if needed the fourth and fifth start times. During programming, the screen also shows which days the controller will operate.

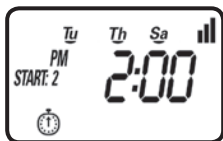

Press the  button to proceed to the next step RUN TIME  or to review the program.





## 9. SETTING WATERING RUN TIMES

**Note:** If you have already set a SimpleSmart™ ET preset (example: SP02) and then change the run time, your SimpleSmart™ program will be turned OFF. You must reactivate the SimpleSmart™ programming each time you adjust your run time (see section 10).

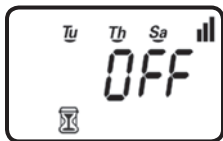
This setting determines the length of time the LEIT-1™ smart controller will allow the valve to remain open (duration is from 1 minute up to 6 hours). For example, setting watering run time to 10 minutes on certain days of the week will program the controller to turn the water on for 10 minutes on each of the days chosen and at every start time selected.



To set the watering run time :

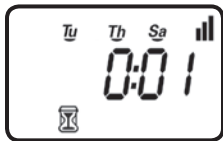

1. Press the  button until the  icon appears and OFF or the last run time setting appears.
2. Press the  button, and OFF (or the last run time programmed) appears with hours blinking.
3. To set a desired watering run time in hours, press  or  and select the number of hours.



4. If only watering duration in minutes is required, press  to skip the hour digit, and the minutes will start blinking.

5. To set the desired watering duration in minutes (example of 10 minutes), press  or  to select minutes. When programming the watering duration the screen will also show the days the controller will operate.

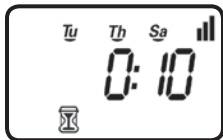

**NOTE:** If the last data entered stops blinking after 10 seconds, press  again to resume or  to move backward.

Press the  button to proceed to the next step SET ET  or to review the program.

## 10. SETTING THE SIMPLESMART™ OPTION (SET ET)

The LEIT-1™ smart controller's main feature includes twenty preset programs for sprays and drip irrigation based on three years of historical evapotranspiration (ET) from various climate regions.

How DIG's LEIT-1™ smart controller operates using Historical Evapotranspiration (ET):

After programming the watering schedule, watering start time and watering duration, the user can select one of the preset SimpleSmart™ evapotranspiration (ET) programs for spray or drip irrigation systems. See the color map in the centerfold of this manual to select the appropriate pre-set for your location and type of system to reference CHART A on page 16 and choose from the region description.

Selecting SP01 through SP20 sets the LEIT-1™ controller to water a predetermined number of minutes per month. The amount to water is pre-programmed into the controller and is determined by which program (SP) is selected and by the month.

If you have already set a SimpleSmart™ ET preset (example: SP02) and then change the run time, your SimpleSmart™ program will be turned OFF. You must reactivate the SimpleSmart™ programming each time you adjust your run time (see section 10).

**NOTE: If using one of the SimpleSmart™ presets we recommend evaluating the plants' health for the first month and making adjustments to the system as needed. If an adjustment or fine tuning of the SimpleSmart™ programming is required, this adjustment can be made for each month in the SEASONAL ADJUSTMENT (%) SETTING (see section 11).**

CHART A - SELECTING HISTORICAL ET PROGRAM

PROGRAM	REGIONS	IRRIGATION METHOD
SP01	Cool Mediterranean	Drip Systems
SP02	Cool Mediterranean	Sprinkler Systems
SP03	Humid Continental	Drip Systems
SP04	Humid Continental	Sprinkler Systems
SP05	Warm Mediterranean	Drip Systems
SP06	Warm Mediterranean	Sprinkler Systems
SP07	Humid Sub-Tropical	Drip Systems
SP08	Humid Sub-Tropical	Sprinkler Systems
SP09	Highlands	Drip Systems
SP10	Highlands	Sprinkler Systems
SP11	Dry Inland Valleys	Drip Systems
SP12	Dry Inland Valleys	Sprinkler Systems
SP13	Tropical Wet & Dry	Drip Systems
SP14	Tropical Wet & Dry	Sprinkler Systems
SP15	Tropical Wet	Drip Systems
SP16	Tropical Wet	Sprinkler Systems
SP17	Semi-Arid	Drip Systems
SP18	Semi-Arid	Sprinkler Systems
SP19	Arid	Drip Systems
SP20	Arid	Sprinkler Systems



For example:

The user entered watering run time will be adjusted monthly based upon the forecast ET pattern for the selected region.



By selecting SP02, the controller may adjust the programmed run time of 10 minutes in the month of January to 3 minutes, or less. This reduces the irrigation run time by 7 minutes, providing a water savings of nearly 70% for the month of January.

To activate the SimpleSmart™ ET feature:

1. Press the  button until the  icon appears and OFF appears.



2. Press  and OFF (or the last SP program #) appears.

3. To select a desired SimpleSmart™ preset press  or  and select one of the twenty programs from the list using one that is similar to your climate region and irrigation method (see map in centerfold or reference Chart A).



4. To deactivate the preset program, press  and the program # appears blinking.
5. Press  until OFF appears.

Press the  button to proceed to the next step SET BUDGET  or to review the program.

## 11. SETTING SEASONAL ADJUSTMENT (MONTHLY BUDGET)

The amount of water required by plants varies throughout the year. The Seasonal Adjustment percentage feature can be utilized to alter the programmed watering run time on a monthly basis.



This program features two options:

- A.** It can be used as an adjustment to the programmed run time by altering the programmed watering duration on a monthly basis.
- B.** It can be used to modify the total run time setting of the SimpleSmart™ programming per month by percentage.

To set seasonal adjustment in %:

1. Press the  button until 100% and the current month # appears.



2. Press the  button and the 100% appears blinking.
3. To set the desired seasonal adjustment % (0-200%), press  or .  
*Example, if a 20 minute duration is programmed, and then the monthly budget is changed from 100% to 50%, the duration will now be 10 minutes for the selected month.*



4. Repeat the steps to set the desired seasonal adjustment % for each month by pressing  and following the previous steps for each month.

Press the  button to proceed to the next step RAIN DELAY  or to review the program.

## 12. RAIN DELAY SETTING



The Rain Delay setting is used to temporarily suspend all irrigation for a defined number of days. For example, during rainy weather regularly scheduled programs can be turned off from 1-99 days. At the end of the designated period, regularly scheduled programming will resume automatically.

To set a temporary suspension of the program:



1. Press the  button until the  icon appears and OFF appear.



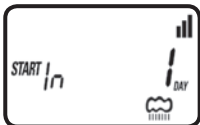

2. Press the  button and OFF starts blinking.

3. To set the desired temporary suspension of the program (1-99 days), press  or .



4. The temporary suspension of the program can be cancelled at any time by re-entering Rain Delay screen and changing the setting to OFF. (Press  or  until OFF appears.)





**Note:** OFF appears in between numeric value of 99 and 1.

Press the  button to proceed to the next step EVENTS OFF  or to review the program.

### 13. EVENTS OFF SETTING



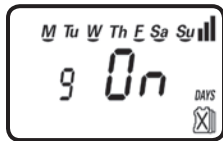

This mode allows the user to program the timer to not water during specific months of the year, or to program the timer to not water on specific days of the week during a specific month.

#### To turn off specific days of a month:

1. Push the  button until the desired month is selected and DAYS appear above the  symbol. The number of the month is on the left (1 = January, 12 = December).
2. Push the  button until the desired day of the week flashes.
3. Push the  to remove the underline under the day of the week. During the selected month, watering will not occur on the days of the week without the underline.



#### To turn off an entire month:

1. Push the  button until the  icon appears.
2. Push the  button through each day of the week until the MO appears above the  icon.

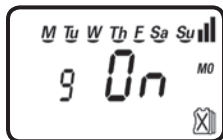

3. When On is flashing for the desired month to turn off, push the  button and the word OFF will appear. The selected month is now turned off, and no watering will occur during the entire month.

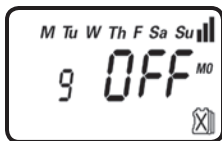

The controller is now fully programmed.

Press the  button to review the program or to return to the home screen.







Here is an example of the home screen showing all the icons of the programs that are currently set and active, which is the SimpleSmart™ (SET ET), monthly budget, rain delay and events off programs.

## 14. MANUAL WATERING

The manual mode allows the user to test the system and water for a specified run time. The controller will automatically close the valve at the end of the defined irrigation period. The originally programmed irrigation schedule continues to function at the times assigned. The sensor condition is disregarded in this mode.

To start a manual run,

1. Press the  button, and the  icon and  icon appears. ON appears momentarily and then the last watering duration is displayed with  . The controller will open the valve and in 10 seconds a count down of the remaining irrigation duration appears, showing when the controller will close the valve.



2. Press the  button to end manual run.
3. After 10 seconds the display will revert to the current time screen.

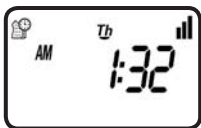

## 15. CONNECTING A RAIN SENSOR

Most “normally closed” rain or soil moisture sensors can be connected to the LEIT-1™ controller. The function of the sensor is to prevent automatic watering by the set program due to excessive rainfall or when the soil is too moist.

**To connect the sensor to the controller, please follow these steps:**

1. Cut the yellow wire loop that exits the controller in the middle of the loop.
2. Strip approximately 1/2 in. of insulation from the end of each wire.
3. Splice one yellow wire to each of the wires coming from the sensor.  
Use waterproof wire connectors to secure the connections.
4. Follow the sensor manufacturer’s instructions for calibrating the sensor.

5. When the sensor is active and preventing automatic operation, a  icon will appear on the display.



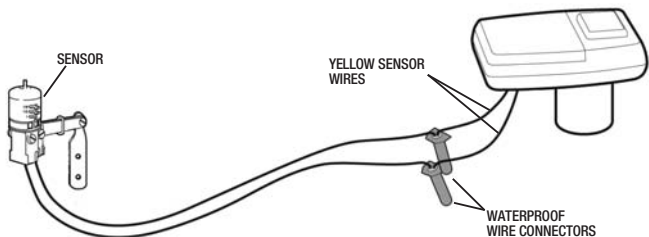

Icon will only appear when sensor is active.



Recommended rain sensors are the Rain Bird RSD and Hunter Mini-Click  
Recommended soil moisture sensor is the Irrrometer WEM-B

## 16. MAINTENANCE, TROUBLESHOOTING AND REPAIRS

To restore the controller to the default settings (Budgeting and Rain Delay settings will remain):

1. Press the  button until the **START EVERY** is displayed and the  icon appears on the bottom left of the screen.
2. Press and hold down the  for three seconds.
3. The screen returns to the home screen (clock) and all the default settings are restored. The current time and date is retained.

**PROBLEM:** Valve is not opening automatically or manually

CAUSE: No water pressure

SOLUTION: Open main water supply valve

CAUSE: Faulty solenoid

SOLUTION: Replace solenoid

CAUSE: Flow control handle is turned down

SOLUTION: Open flow control handle on valve

**PROBLEM:** Valve functions in manual mode but not automatically

CAUSE: Controller is set to OFF mode

SOLUTION: Verify that controller does not show OFF in current time mode

CAUSE: AM/PM not set correctly in current time mode

SOLUTION: Check current time, change AM/PM if necessary

CAUSE: AM/PM not set correctly in start time mode

SOLUTION: Check start time(s), change AM/PM if necessary

CAUSE: Watering restriction or rain delay is preventing watering

SOLUTION: Remove watering restrictions or set rain delay to off

CAUSE: Yellow sensor wires have been cut

SOLUTION: Re-connect sensor wires together with waterproof connector



**CAUSE:** Sensor is installed and is in a state that prevents watering

**SOLUTION:** Check sensor and wire splices and verify sensor is normally closed

**PROBLEM:** The display is blank

**CAUSE:** No buttons have been pushed in the previous 15 minutes

**SOLUTION:** Push any button

**PROBLEM:** Valve fails to close

**CAUSE:** Valve is installed backwards

**SOLUTION:** Check flow arrow and verify arrows points away from water source

**CAUSE:** Debris is blocking solenoid port

**SOLUTION:** Shut off water supply, unscrew and remove solenoid, then open water supply and flush out solenoid port, re-install solenoid

**PROBLEM:** Rain sensor does not prevent watering

**CAUSE:** Rain sensor is normally open, malfunctioning, or not wired correctly

**SOLUTION:** Verify that sensor icon appears on display when pin is pushed down & check all wire splices

**PROBLEM:** Controller waters more than once per day

**CAUSE:** More than one start time has been programmed

**SOLUTION:** Change start time 2,3,4, and 5 to OFF

**PROBLEM:** Solenoid is not fully closed after using manual operation.

**SOLUTION:** Lift the controller and turn solenoid clockwise to fully closed position.

**PROBLEM:** Solenoid or adapter O-rings are damaged or twisted.

**SOLUTION:** Turn off the water supply. First turn the solenoid counter-clockwise to remove and inspect the O-ring, and then turn it counter-clockwise and repeat the inspection. Clean any debris or replace the O-ring as necessary.

## 17. WARRANTY

DIG CORPORATION warrants these products to be free from defects in material and workmanship for a period of three years from date of purchase. This warranty does not cover damage resulting from accident, misuse, neglect, modification, improper installation or subjection to line pressure in excess of 150 lbs. per square inch (10.3 BAR). This warranty shall extend only to the original purchaser of the product for use by the purchaser.

The obligation of DIG CORPORATION under this warranty is limited to repairing or replacing at its factory this product which shall be returned to the factory within three years after the original purchase and which on examination is found to contain defects in material and workmanship. **DIG CORPORATION SHALL IN NO EVENT BE LIABLE FOR ANY INCIDENTAL OR CONSEQUENTIAL DAMAGES OF ANY KIND; THE SOLE OBLIGATION OF DIG BEING LIMITED TO REPAIR OR REPLACEMENT OF DEFECTIVE PRODUCTS. SOME STATES DO NOT ALLOW THE EXCLUSION OR LIMITATION OF INCIDENTAL OR CONSEQUENTIAL DAMAGES, SO THE ABOVE LIMITATION OR EXCLUSION MAY NOT APPLY TO YOU.**

Unattended use for prolonged periods without inspection to verify proper operation is beyond the intended use of this product, and any damage resulting from such use shall not be the responsibility of DIG CORPORATION. There are no warranties, which extend beyond the description on the face hereof. In the case of purchase of the product for use other than, for irrigation purposes, DIG CORPORATION hereby disclaims any implied warranties including any warranties of merchantability and fitness for a particular purpose. In the case of the purchase of the product for personal, family or household purposes, DIG CORPORATION disclaims any such warranties to the extent permitted by law. To the extent that any such disclaimer or implied warranties shall be ineffectual, then any implied warranties shall be limited in duration to a period of three years from the date of the original purchase for use by the purchaser. Some states do not allow limitation on how long an implied warranty lasts, so the above limitation may not apply to you.

In order to obtain performance under this warranty, the unit must be returned to the factory, along with proof of purchase indicating original date of purchase, shipping prepaid, addressed as follows:

DIG CORPORATION, 1210 Activity Drive, Vista, CA 92081. Repaired or replaced units will be shipped prepaid to the name and address supplied with the unit returned under warranty. Allow four weeks for repairs and shipping time. Repair of damaged units not otherwise within warranty may be refused or done at a reasonable cost or charge at the option of DIG CORPORATION.

This warranty gives you specific legal rights, and you may also have other rights, which vary from state to state.

## 18. TECHNICAL ASSISTANCE

Should you encounter any problem(s) with this product or if you do not understand its many features, please refer to this instruction manual first. If further assistance is required, DIG offers the following customer support:

### TECHNICAL SERVICE USA

- DIG's Technical Service Team is available to answer questions in English and Spanish from 8:00 AM to 5:00 PM (PST) Monday-Friday (except holidays) at 800-344-2281 or 760-727-0914.
- Questions in English and Spanish can be emailed to [questions@digcorp.com](mailto:questions@digcorp.com) or faxed to 760-727-0282.
- Specification documents and manuals are available for downloading in English and Spanish at [www.digcorp.com](http://www.digcorp.com).



1210 Activity Drive  
Vista, CA 92081-8510, USA

[www.digcorp.com](http://www.digcorp.com)  
email: [dig@digcorp.com](mailto:dig@digcorp.com)

26-209 REVA 021913 DIGCORP  
Printed in the USA

DIG is a Registered Service Mark of DIG Corporation

