

NODE



EN

Battery-Operated Controller

Owner's manual and programming instructions

ES

Programador de pilas

Manual del usuario e instrucciones de programación

FR

Programmateur à piles

Manuel de l'utilisateur et consignes de programmation

IT

Programmatore a batteria

Manuale dell'utente e istruzioni per la programmazione

DE

Batteriebetriebenes Steuergerät

Bedienungs- und Programmieranleitung

PT

Controlador de Funcionamento a Pilhas

Manual do Proprietário e Instruções de Utilização

TR

Pilli Kontrol Ünitesi

Kurulum, Programlama ve Kullanım Kılavuzu

Hunter®

TABLE OF CONTENTS

EN

NODE FEATURES	2
NODE COMPONENTS	3
Control Buttons	
LCD Display	
CONNECTING THE BATTERY/BATTERIES	4
ATTACHING SOLENOIDS	5
To Wire DC Solenoids to the NODE	
To Mount the NODE to a Valve (Figure 1)	
MOUNTING THE NODE	6
CONNECTING A WEATHER SENSOR	6
Setting the Date and Time	
IDLE MODE	7
RUN MODE	7
PROGRAMMING	7
Setting Watering Start Times	
Setting the Run Times	
Setting Watering Days	
Selecting Odd/Even Days to Water	
Selecting Interval Days to Water	
Setting the Seasonal Adjustment	
Turning the System Off	
Manual Watering	
Sensor Operation	
ADVANCED PROGRAMMING FEATURES	12
Sensor Bypass	
Easy Retrieve Memory	
Setting Master Valve Operation (NODE-200, NODE-400, & NODE-600 Only)	
Programmable Off (Up to 99 Days)	

BATTERY-LIFE INDICATOR	14
RESETTING CONTROLLER	14
TROUBLESHOOTING GUIDE	15
SPECIFICATIONS	16
NOTES	17

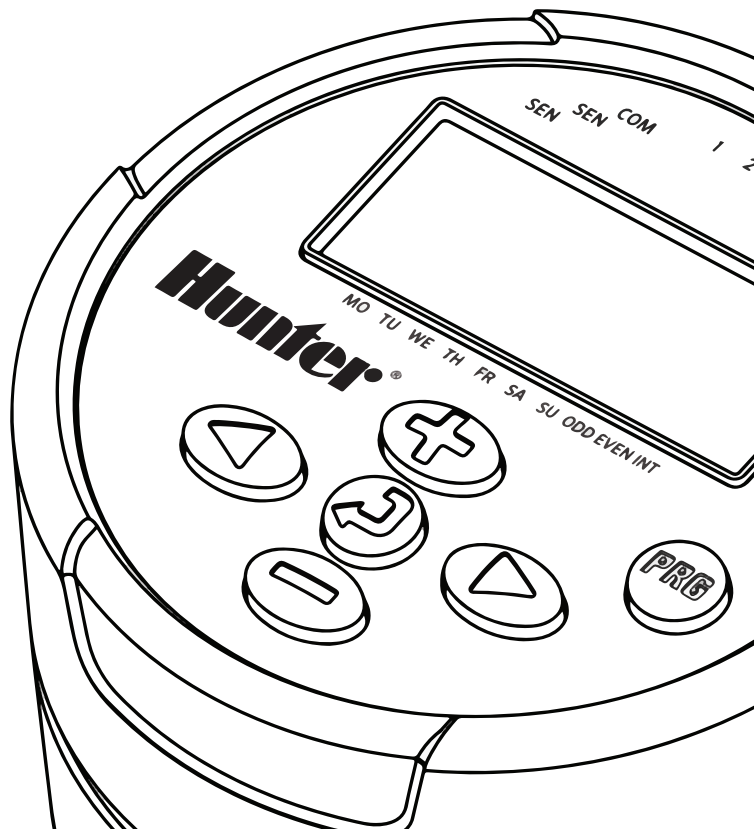

- Simple push-button programming
- Single-station model (NODE-100) with DC latching solenoid. Single-, two-, four-, or six-station models are also available (solenoids not included).
- Large Liquid Crystal Display (LCD) with easy-to-understand icons
- Operates using at least one standard nine-volt alkaline battery (use two for extended battery life)
- Three programs (A, B, or C) with up to four start times each
- Run times from one minute to six hours
- Manual watering capabilities
- Battery-life indicator
- Wired rain sensor compatible
- Non-volatile memory retains all program information
- Seasonal Adjustment from 10-150%
- Easy Retrieve™ memory allows saving/retrieval of preferred program data
- Manual bypass of rain sensor
- Total Run Time Calculator shows total program irrigation time per program

NODE COMPONENTS

This section provides an overview of some of the components of the NODE. Each item will be discussed in further detail later. However, this section can be helpful in getting acquainted with the different options available.

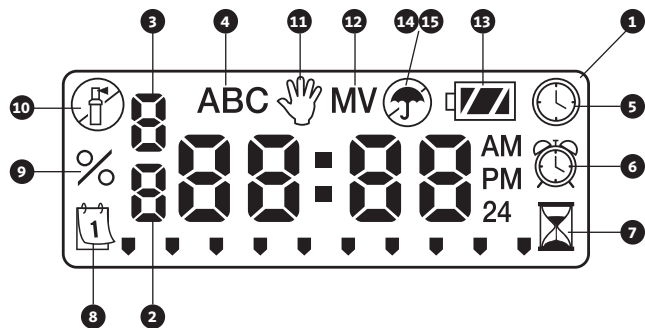

Control Buttons

1. **+** **Button** - Increases the selected flashing display
2. **-** **Button** - Decreases the selected flashing display
3. **↻** **Button** - Selects programming function
4. **▶** **Button** - Advances the selected flashing display back to the next item
5. **◀** **Button** - Navigates the selected flashing display back to the previous item
6. **PRG** **Button** - Selects the program (A, B, or C)

LCD Display

1. **Main Display** - Indicates all program information
2. **Station Number** - Indicates the station number being programmed
3. **Start Time Number** - Indicates the start timer number being programmed
4. **Program** - Indicates the program (A, B, or C)
5. **Current Time/Day** - Indicates when current day/time is being set
6. **Start Times** - Indicates when start times are being set
7. **Run Times** - Indicates when Run Times are being set. Allows user to set run times from one minute to six hours.
8. **Watering Days** - Allows the user to select individual days to water or a selected number of days between watering (interval)
9. **% Seasonal Adjustment** - Allows the seasonal adjustment to be programmed from 10-150% (default value is 100%)
10. **System Off** - Indicates that watering is suspended
11. **Manual On/Off** - Indicates when manual watering is programmed. Allows the user to activate the station manually.
12. **MV** - Indicates that station one is set to master valve operation (only available on two-, four-, or six-station models)
13. **Battery Status** - Indicates remaining battery life
14. **Umbrella** - Indicates the rain sensor is suspending irrigation
15. **Crossed Umbrella** - Indicates the rain sensor has been manually bypassed

CONNECTING THE BATTERY/BATTERIES

The NODE uses one or two standard nine-volt batteries (not included) to operate the valves and program the controller. The controller can operate using either a single nine-volt battery or using two nine-volt batteries. Under normal conditions, the expected life is one year for a single battery and two years when using two nine-volt batteries.



NOTE: The NODE has non-volatile memory. This allows the battery to be removed without losing program information.

To Install the Battery/Batteries

1. Unscrew the rear body of the NODE body to gain access to the battery compartment.
2. Insert the battery/batteries into the battery tray and connect to the controller using the battery connector.
3. Make sure that no water is inside the battery compartment.
4. Screw the NODE rear body back onto the front half.



NOTE: Verify that the seal marker on the rear half of the NODE lines up with the front half, ensuring that a proper seal is created.

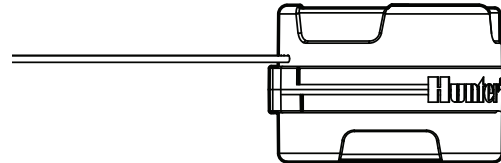
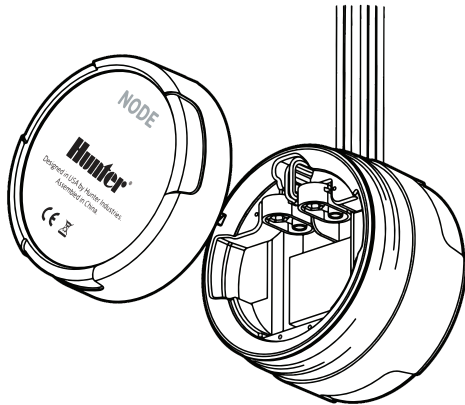

ATTACHING SOLENOIDS

The NODE-100 is provided with a solenoid attached to the controller. The NODE-100-LS does not include a solenoid. The NODE-200, NODE-400, and NODE-600 multi-station controllers will operate up to two, four, or six solenoids, respectively. Hunter DC-latching solenoids (P/N 458200) can easily be installed on all Hunter plastic valves.



NOTE: Use DC latching solenoids operating between 9-11 VDC. 24 VAC solenoids will not operate with the NODE.

To Wire DC Solenoids to the NODE

1. Attach the black leads from each solenoid to the single common wire (black lead) coming from the NODE. Secure all wire connections with waterproof connectors.
2. Attach one red wire from each solenoid to the corresponding station wire (red lead) from the NODE. The station numbers are identified on the face of the NODE. Secure all wire connections with waterproof connectors.



NOTE: The maximum wire distance between the solenoid and NODE is 100' (30 m) using 18 AWG (1 mm) minimum wire size.

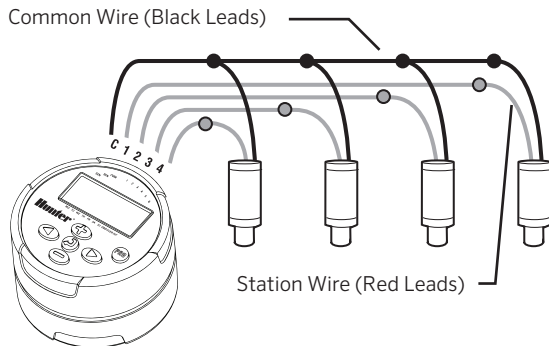

MOUNTING THE NODE

The NODE can easily be mounted on any Hunter plastic valve. A specially designed valve mounting clip makes installation a snap. A protective rubber cover is provided to prevent dirt from accumulating on the face of the NODE.

To Mount the NODE to a Valve (Figure 1)

1. Screw the Hunter DC latching solenoid (P/N 458200) into the valve bonnet.
2. Set the small open end of the NODE holder on top of the solenoid.
3. Set the NODE controller into the large open end of the NODE holder.

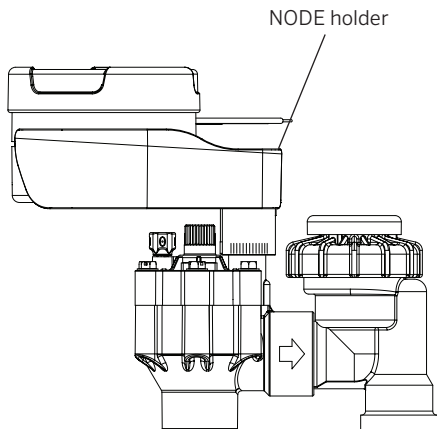

Figure 1

CONNECTING A WEATHER SENSOR EN

A Hunter Mini-Clik® or Wired Rain-Clik® rain sensor can be connected to the NODE. The purpose of this sensor is to stop watering when weather conditions dictate.



NOTE: When the Wired Rain Sensor is interrupting the watering, the display will show the System Off icon ☹️, "OFF" and 🌧️ on the display.

1. Cut the yellow wire loop attached to the NODE at approximately the middle of the loop.
2. Remove approximately ½" (13 mm) of insulation from each wire. Attach one yellow wire to each of the wires of the weather sensor. You can mount the rain sensor up to 100 ft (30 m) from the NODE controller (18 AWG/1 mm minimum wire size).
3. Secure wire connections with waterproof connectors.

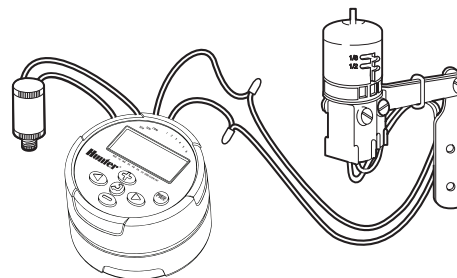

Hunter Model Mini-Clik®

IDLE MODE

Normally, the NODE display shows the time and day, day of the week, MV (if master valve option is activated), and the battery-life indicator. After a short period of inactivity, the display will shut off to retain battery power. Pressing any button will bring the NODE into idle mode.

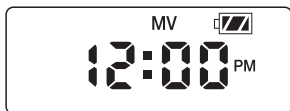





RUN MODE

When the controller is operating a program, the items shown on the display will include the station number, program letter, remaining run time, and the blinking Rotor icon.

















PROGRAMMING

EN

The NODE uses standard Hunter controller programming with three programs (A, B, or C) and four start times per program. On standard Hunter controllers a dial is used to scroll between the programming functions. However, on the NODE the  button is used to quickly and easily create the irrigation program. When programming, the flashing portion of the display can be changed by pressing the  or  buttons. To change something that is not flashing, press the  or  buttons until the desired item is flashing.









Setting the Date and Time

1. Push the  button until the  icon is displayed.
2. All four digits will be displayed representing the year. Use the  or  buttons to change the year. Press the  button to proceed to setting the month.
3. All four digits will be displayed with the two digits on the left representing the month flashing. Use the  or  buttons to change the month. Press the  button to proceed to setting the day.
4. Only the two digits on the right side will be displayed and flashing, representing the day. Press the  or  buttons to change the day. Press the  button to proceed with changing the hour. Press the  button to proceed to setting the time.
5. The AM/PM/24-hour time setting is shown flashing. Press the  or  button to change the time setting to AM, PM, or 24-hour time. Press the  button to proceed to setting the hour.







PROGRAMMING (CONTINUED)

EN

- All four numbers are shown with the two numbers on the left flashing, representing the hour. Use the  or  buttons to change the hour. Press the  button to proceed to setting the minutes.
- All four numbers are shown with the two numbers on the right flashing, representing the minutes. Use the  or  buttons to change the minutes. Pressing the  button will advance to the year setting at Step 2.
- Press the  button to proceed to the next programming function or allow controller to return to idle mode.









Setting Watering Start Times

- Press the  button until the  icon is displayed.
- The start time will be displayed flashing, along with the program letter (A, B, or C) and the start time number (1, 2, 3, or 4) in the upper left of the display. Up to 4 different start times can be set for each program.
- Use the  or  buttons to change the start time for the program that is displayed. Each press of the button will change the start time in one-minute increments.
- Press the  button to add an additional start time to the program displayed. The start time number is shown in the upper left corner of the display.
- Press the  button to add start times to a different program.
- Press the  button to proceed to the next programming function or allow controller to return to idle mode.



NOTE: After programming the run time for the last station press the  button to display the total run time for the program.









Setting the Run Times

- Press the  button until the  icon is displayed.
- The run time will be displayed flashing. Also shown is the program letter (A, B, or C) and the active station number on the lower left side of the display. Press the  or  buttons to change the station run time from one minute to six hours.
- Press the  button to advance to the next station.
- Press the  button to add a run time to another program.
- Press the  button to proceed to the next programming function or allow controller to return to idle mode.



PROGRAMMING (CONTINUED)



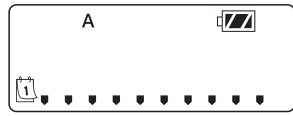
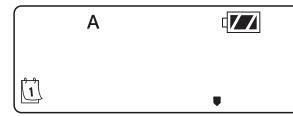

Setting Watering Days

1. Press the  button until the  icon is displayed.
2. The program letter (A, B, or C) will be displayed.
3. Arrows point at the specific days of the week on which watering will occur. Press the  or  buttons to scroll through the days.
4. Press the  button to activate that day for the program displayed, or the  button to cancel watering for that day. **The arrow will show on the watering days for the active program.**
5. Press the  button to set days to water for a different program, if desired.
6. Press the  button to proceed to the next programming function or allow controller to return to idle mode.









Selecting Odd/Even Days to Water

This feature uses numbered days of the month for watering instead of specific days of the week.



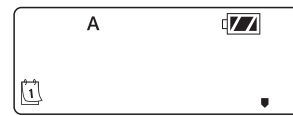

1. Press the  button until the  icon is displayed.
2. Press the  button until the cursor is above either ODD or EVEN on the display.
3. Press the  button to select, or the  button to cancel either ODD or EVEN days to water.
4. Once ODD or EVEN mode is activated, it will be the only cursor shown on the display.

Selecting Interval Days to Water

1. Press the  button until the  icon is displayed.
2. Press the  button until the cursor is above **INT** on the display.
3. Press the  button and a 1 will be flashing, indicating the number of days between watering.
4. Press the  or  buttons to select the number of days between watering days (1 to 31).



Setting the Seasonal Adjustment

1. Press the  button until the  is displayed.
2. Press the  or  button to increase or decrease the seasonal adjustment value from the default 100% (down to a minimum of 10% or a maximum of 150%).
3. The value programmed for seasonal adjustment will be applied to all irrigation programs and will immediately be reflected in

the run times displayed. For example, if 20-minute run times are programmed and then the seasonal adjustment is changed from 100% to 50%, the run times displayed will be 10 minutes.



Turning the System Off

To turn your controller off, press the button until the icon and **OFF** is displayed on screen. To return the controller to auto programming mode, press the button. The controller will immediately return to auto programming mode and will display the time and battery-life indicator.



Manual Watering

Manual Watering allows the user to test each station or a program for a specified run time. The weather sensor condition (if used) will be disregarded in this mode.

1. Make sure the controller is in idle mode. Press and hold the button until the icon is displayed.
2. The station number will be displayed in the lower left side of the display along with the run time.
3. Use the and buttons to select the desired station and the and buttons to set the manual watering time for the station shown.

4. To manually activate a program, press the button. The program letter (A, B, or C) will show on the screen. If a different program is needed, press the button until the desired program is displayed.
5. To stop the Manual Watering cycle, press the button until the time is reduced to zero.
6. Press the button to proceed to the next programming function or allow controller to return to idle mode.



NOTE:

- Pressing the or buttons when a station is running in Manual Watering mode will modify the irrigation time for that station.
- Pressing the button when a station is running in Manual Watering mode will stop irrigation on the current station and advance to the next station.
- Pressing the button when a station is running in Manual Watering mode will stop irrigation on the current station and revert to the previous station.

Sensor Operation

The NODE is compatible with Hunter Clik-type rain sensors, including Mini-Clik®, Freeze-Clik, and Wired Rain-Clik®, as well as many other interrupt-type devices/sensors that do not require power. Simply connect the sensor to the NODE controller by cutting the yellow wire loop and connecting to the sensor wires.



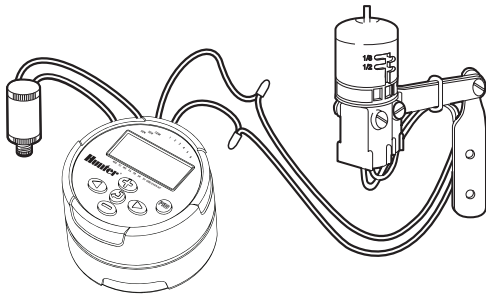

NOTE: NODE is not compatible with Hunter Wireless Rain-Clik® or other weather devices that require 24 VAC power.

When the sensor is activated, it will suspend irrigation and the ☂ icon will show on the display.





All advanced programming functions are initiated from the idle mode, which shows the time, day of the week, and battery-life indicator on the display. If something is flashing on the display then the controller is in one of the programming modes. After a short period of inactivity the controller will return to idle mode.



Sensor Bypass

1. From the idle mode, press and hold the  button until the  icon is displayed.
2. The display will show the umbrella icon flashing and **ON**.



3. Press the  button to bypass the sensor. The display will show  and **OFF** to indicate the weather sensor is bypassed. The  icon will show on the display during normal operation, indicating the controller is in bypass mode.





4. To reactivate the weather sensor, press and hold the  button until the  icon is displayed. Press the  button to return to normal sensor mode.

Easy Retrieve Memory



This function allows the user to save a preferred program to permanent memory in the controller, which can be restored at any time. This is a great way to override changes made, and revert back to the original programming schedule.

To save a program:

1. Make sure that the controller is programmed with the preferred programming schedule.
2. From idle mode, press and hold the  and  button for five seconds to save the current program.
3. The screen will show three dashed lines moving from left to right to indicate the current program is being saved to permanent memory. The display will flash **DONE** when the process is complete.



To retrieve a saved program:

1. From idle mode, press and hold the  and  button for five seconds.
2. The screen will show three dashed lines moving from right to left to indicate the preferred program is being retrieved from memory.



The controller now has the preferred program as the current program. The display will flash **DONE** when the process is complete.



NOTE: Be careful when using Easy Retrieve memory. Saving program data to memory using Easy Retrieve will take the current program information and override whatever is saved in permanent memory. When saving program data, make sure that the current program data is what you want saved.

Setting Master Valve Operation (NODE-200, NODE-400, & NODE-600 Only)

The multi-station NODE models (NODE-200, NODE-400, and NODE-600) can be programmed with the use of a normally closed master valve. When programming with the master valve you will be assigning Station 1 as the master valve, effectively losing the use of Station 1 for activation of an irrigation station.

1. From the idle mode, press the  button until the  icon is displayed.
2. Program A will be displayed along with the active station number on the lower left. Make sure the active station showing is "1." The run time will be shown.





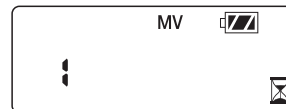

3. Press the  button once and the **MV** icon will display on the screen and the time will disappear. Station 1 is now acting as the master valve and will not be available in other programming screens.



4. When the master valve is activated, it will apply to all programs and the **MV** icon will stay displayed on the screen at all times.

Programmable Off (Up to 99 Days)

This feature permits the user to stop all programmed watering for the designated period from 1-99 days. At the end of the programmable off period, the controller will resume normal operation.

1. From idle mode, press the  button until the  icon is displayed. Wait two seconds until **OFF** is shown on the display. The controller is now in System Off mode.
2. Press the  button and a blinking "1" will be displayed, indicating the number of days the controller will stay off. Program the off days as desired, up to 99 days maximum.
3. The display will show the number of days remaining in the **OFF** period.
4. To interrupt the **OFF** period, press the  button to return to the idle mode screen, showing the time of day and day of the week.

BATTERY-LIFE INDICATOR

The remaining battery life can be estimated from the battery-life indicator shown on the display. The NODE can operate using either a single nine-volt battery or using two nine-volt batteries. Using two nine-volt batteries will yield approximately twice the battery life of a single nine-volt battery. The battery-life indicator chart below shows an estimate on the remaining battery life.

 Full: 100-60% remaining battery life

 Med: 60-25% remaining battery life







 Low: 25-0% remaining battery life

 Replace battery immediately!

RESETTING CONTROLLER

EN

Resetting the controller will erase the current program data and restart the controller. A reset does not, however, delete a program saved to permanent memory using the Easy Retrieve memory feature (see page 12) to save a preferred program.

1. From idle mode, press and hold the , , and  keys.
2. After two seconds the screen will go blank. Continue to hold the , , and  keys.
3. 12:00 will flash on the display. Release the keys.
4. The controller may show a countdown from 10 to 1 on the display, and then 12:00 AM will be shown flashing when the reset is complete. The controller can now be reprogrammed.

TROUBLESHOOTING GUIDE

EN

Problem	Causes	Solutions
There is no display.	Display is off. Battery is dead.	Press any button for one second. Replace the battery.
Display indicates watering but none is occurring.	No water pressure. Faulty solenoid. Incompatible solenoid.	Turn on main system supply. Replace solenoid. Must use Hunter DC latching solenoid (P/N 458200) or other compatible DC latching solenoid.
Automatic irrigation does not start at start time.	Controller in System Off mode. AM/PM/time of day not set correctly. AM/PM/start time not set correctly.	Verify that controller is programmed for automatic watering. Correct AM/PM/time of day. Correct AM/PM/start time.
Rain sensor does not suspend watering.	Rain sensor defective or miswired.	Verify proper operation of the rain sensor and wire connections (see page 11).
Controller waters more than one time.	The program has more than one start time assigned to it. Each program has up to four start times.	Eliminate program start times as needed.

SPECIFICATIONS

Dimensions: 3 ½"(89 mm) diameter, 2 ½"(64 mm) high

Sensor inputs: One

Power source: One nine-volt alkaline battery (use two for extended battery life). Activates DC latching solenoids operating 9-11VDC (Hunter PN 458200).

Operating temperature: 0°F to 140°F (-17°C to 60°C)

Approvals:

IP68
CE
FCC
C-Tick

Hunter®

Hunter Industries Incorporated

1940 Diamond Street • San Marcos, California 92078, USA
www.hunterindustries.com/global

© 2018 Hunter Industries Incorporated

LIT-560 C 6/18