

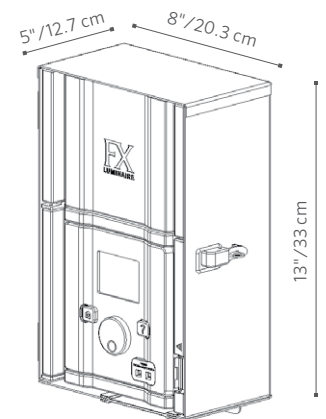

With Luxor controlling an LED landscape lighting system, lights don't simply turn on and off. They come alive. Luxor offers both zoning and dimming capabilities that provide virtually limitless design possibilities. The new Luxor ZDC has all the features of the Luxor ZD + Color. ZDC offers 30,000 different color choices for unmatched ability to customize landscape lighting for any occasion, season, or mood.

LUXOR: Lighting Controller

MODELS:	LZD or LZDC
WATTS:	150 or 300 Watt
FINISHES:	Stainless Steel or Matte Gray Powder Coat
DEPTH:	5" / 12.7 cm
WIDTH:	8" / 20.3cm
HEIGHT:	13" / 33 cm





LUXOR: Lighting Controller

FACTORY INSTALLED OPTIONS: Order 1 + 2 + 3

Step	Description	Code
1	TRANSFORMER	LZD, LZDC
2	SIZE	150, 300
3	FINISH	SS, M

EXAMPLE: **LZD-150-M** = Luxor Transformer - 150W - Matte Gray Finish

FIELD INSTALLED OPTIONS: Order individually

Description	Code
Wi-Fi module with antenna	FXWIFIMOD
LAN module for cat5 connection	FXLANMOD
Light Assignment Module for iOS & Android	LAM
Luxor Faceplate Mount	LUXORFPMNT

EXAMPLE: **LAM** = Light Assignment Module

LUXOR ZD FEATURES:

- Create up to 250 independently adjustable lighting groups
- Compatible with FX LED devices only
- Turn on and dim (from 1 to 100%) all groups independently
- Utilizes ZD Technology and ZDC Technology (ZDC only) to allow controller to communicate with the luminaires
- User interface includes a full color LCD display for easy setup, maintenance and adjusting of groups
- Uses event based scheduling, allowing a group of lights to change dimming percentages throughout the night
- Removable facepack capable of remote mounting up to 500' (200' with Wi-Fi/LAN modules)
- Simple two-wire configuration for easy installation and adjusting
- Address fixtures on the front of the facepack for easy access
- No matter where a light is within a system, it can communicate with the transformer to receive its schedule, intensity, and group
- Astronomical timing function with map placement

LUXOR ZDC FEATURES:

- Create a personalized color palette of 250 user-saved options
- Input hue and saturation settings to generate custom colors
- Offers 30,000 color choices, with 3 million combinations

METALS



POWDER COAT



The Luxor is available in 150 or 300 watt options, choice of stainless steel or matte gray powder coat and a 3' power cord.

WI-FI-OPTIONS



Smartphone with Luxor Wi-Fi App to wirelessly adjust lighting at any time

Smartphone with Light Assignment Module (LAM) which wirelessly assigns fixtures to groups using ActivAssign™ technology



Luxor ZD



Luxor ZDC



ZDC: PHOTOMETRICS

PHOTOMETRICS:

NP-ZDC 3LED ILLUMINANCE AT A DISTANCE

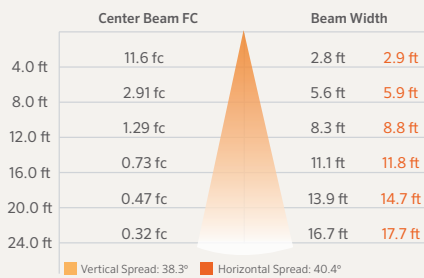

VS-ZDC 3LED ILLUMINANCE AT A DISTANCE

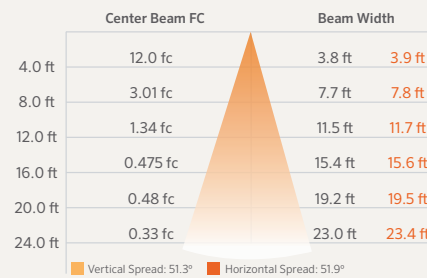

LC-ZDC 3LED ILLUMINANCE AT A DISTANCE

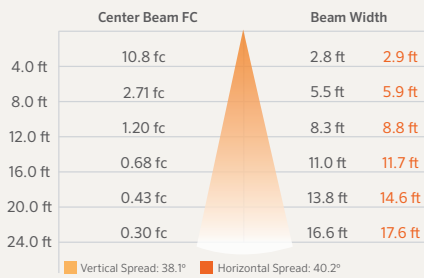

DE-ZDC 3LED ILLUMINANCE AT A DISTANCE

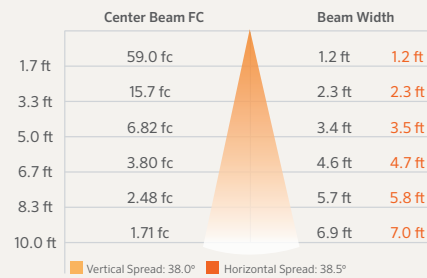

NL/PS-ZDC 3LED ILLUMINANCE AT A DISTANCE

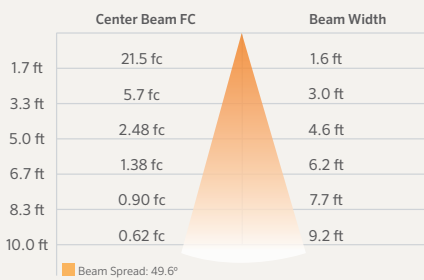

FC-ZDC 3LED (RG) ILLUMINANCE AT A DISTANCE

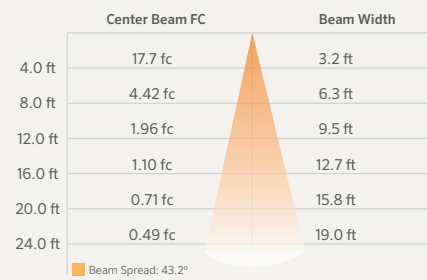

PE-ZDC 3LED ILLUMINANCE AT A DISTANCE

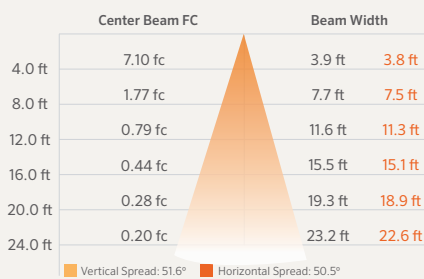

KG-ZDC 3LED ILLUMINANCE AT A DISTANCE

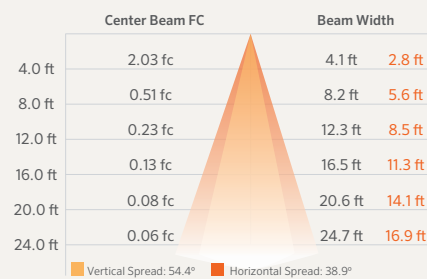

ZDC: PHOTOMETRICS

PHOTOMETRICS:

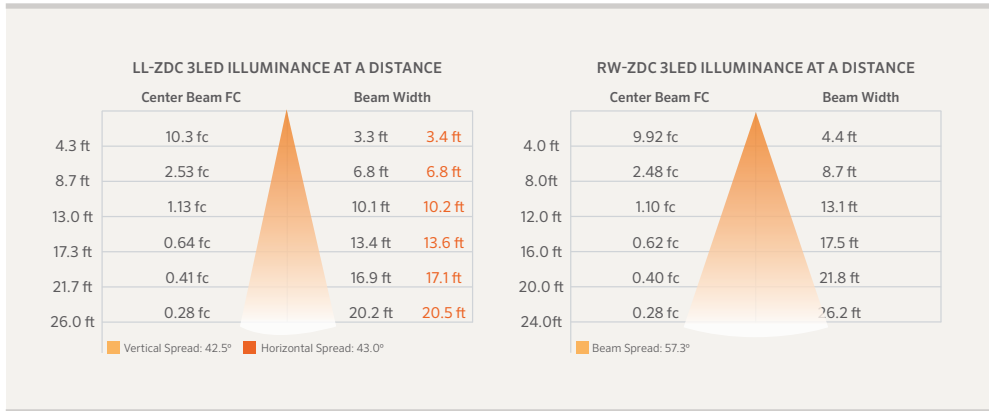

PHOTOMETRICS:

