

SPECIFICATION SHEET **FEBCO®**

Series 767FR

Freeze-Resistant Pressure Vacuum Breakers

Sizes: 1/2" – 2" (15 – 50mm)

Series 767FR is designed to prevent backsiphonage of contaminated water under continuous pressure into the potable water supply. Its superior design protects the valve body and internal components during sudden freeze conditions. Water inside the PVB freezes from the outside-inward.

As the ice forms and expands causing a buildup of pressure, the 767FR relieves the pressure through a unique relief valve built into the plastic float.

Test cocks are positioned at the lowest point of the valve for winterization draining. The 767FR is reusable with the relief valve designed to automatically re-seat. It will not discharge through the relief valve during normal operation. (The built-in relief valve is not designed to provide freeze protection for the entire irrigation system.)



767FR
Patent #5551473

Features

- Unique built-in relief valve relieves pressure caused by ice formation
- Replaceable plastic seat
- Easy maintenance of internal parts
- O-ring bonnet seal for less possibility of fouling
- Silicone seat disc for durability
- Test cocks positioned for easy testing and winterization
- Compact space saving design
- Standardly equipped with tee handle quarter turn ball valve shutoffs 1/2" – 1" (15 – 25mm). The 1 1/4" – 2" (32 – 50mm) feature lever handles
- No special tools required for servicing
- Bronze body for durability

Specifications

A pressure anti-siphon vacuum breaker shall be installed where indicated on the plans to prevent the backsiphonage of contaminated water. This assembly is not to be used where there is a possibility that a backpressure condition may develop. The assembly will incorporate an acetal bonnet with silicone rubber O-ring seal and silicone rubber seat disc. The valve shall have replaceable seats. Check assembly shall be guided over its full stroke by 'V' notch guides. The assembly shall include an internal, built-in relief valve designed to protect the internal components and the backflow body from freezing. The relief valve shall be repeatable, automatically re-seating when the pressure within the valve is below the set point of the freeze relief valve. The assembly shall meet the requirements of ANSI/ASSE Standard 1020. The valve shall be a FEBCO Series 767FR.

Job Name _____

Job Location _____

Engineer _____

Approval _____

Contractor _____

Approval _____

Contractor's P.O. No. _____

Representative _____

FEBCO product specifications in U.S. customary units and metric are approximate and are provided for reference only. For precise measurements, please contact FEBCO. FEBCO reserves the right to change or modify product design, construction, specifications, or materials without prior notice and without incurring any obligation to make such changes and modifications on FEBCO products previously or subsequently sold.

Materials

Springs: Stainless Steel

Bonnet: Celcon®

Vent Disc: Silicone Rubber

Disc Holder Float: Polypropylene

Check Valve Disc: Silicone Rubber

Check Valve Seat: Noryl Plastic

Body: Bronze

Celcon® is a registered trademark of Celanese Limited.

Pressure - Temperature

Temperature Range: 33°F to 140° (0.5°C to 60°C)

Maximum Working Pressure: 150psi (10.3 bar)

Minimum Working Pressure: 15psi (103 kPa)

Approvals



Approved by the foundation for Cross-Connection Control and Hydraulic Research at the University of Southern California, Manual Section 10.

Dimensions – Weights

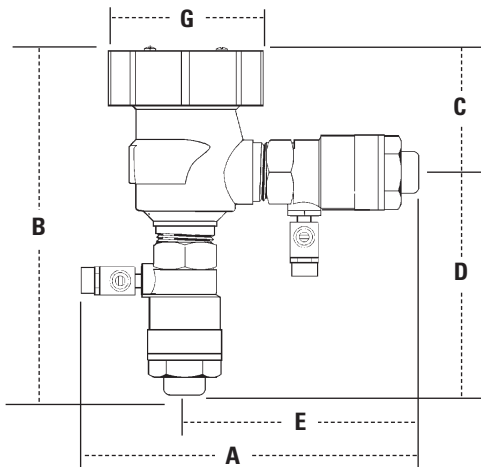

Size: 1/2" - 2" (15 - 50mm)

SIZE (DN)		DIMENSIONS										WEIGHT			
		A		B		C		D		E		G			
in.	mm	in.	mm	in.	mm	in.	mm	in.	mm	in.	mm	in.	mm	lbs.	kg.
1/2	15	6 1/8	156	6 1/4	159	2 9/16	65	3 11/16	94	3 7/8	98	2 1/4	57	4	1.8
3/4	20	6 1/2	165	6 1/2	165	2 9/16	65	3 15/16	100	4 1/8	105	2 1/4	57	4	1.8
1	25	7 1/2	191	7 1/2	191	2 3/4	70	4 3/4	121	4 7/8	124	3 7/16	87	6	2.7
1 1/4	32	8 7/8	225	9	229	3 1/4	83	5 3/4	146	6 1/8	156	5	127	11	5.0
1 1/2	40	9 1/4	235	9 1/2	241	3 1/4	83	6 1/4	159	6 3/8	162	5	127	14	6.3
2	50	10 5/8	270	9 5/8	245	3 1/4	83	6 3/8	162	7	178	5	127	19	8.6

Typical Installation

This valve is designed for installation in a continuous pressure potable water supply system 12" above the highest point of the downstream piping. The valve must be installed with the supply connected to the bottom and in a vertical position. Allow adequate space for periodic inspection, servicing or testing. The valve should not be installed in an area where freezing or spillage will cause damage. Adequate drainage/freeze protection must be provided in cold weather applications.

Important Note: 1.5psi (.10 bar) must be exerted against the float spring to seal the float and air inlet. Do not undersize supply and discharge piping.

Important Note: Vacuum breakers are not designed, tested or approved to protect against backpressure backflow or water hammer shock. For protection against backpressure backflow, install FEBCO 825Y/828Y Reduced Pressure Zone Backflow Preventer. For Protection against water hammer shock install a FEBCO Series SA-1 Water Hammer Arrestor utilizing good plumbing practice.

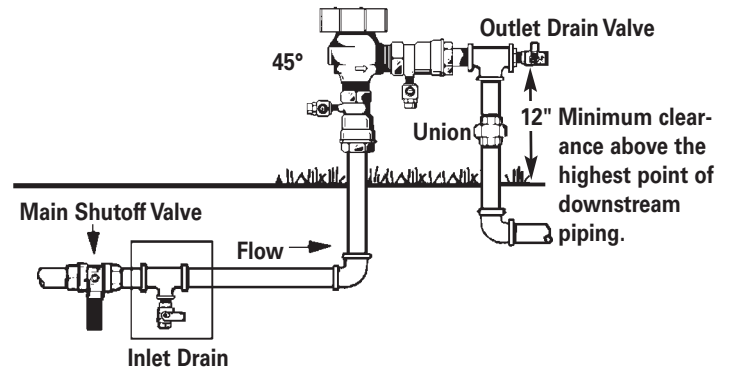

Freeze Protection Guidelines

1. Close main shutoff valve.
2. Open upstream drain, test cocks and isolation ball valves to depressurize line.
3. Purge with air.
4. Leave test cocks and isolation ball valve handles in 45° angle to drain ball valves and prevent casting damage.

Capacity

As compiled from documented Foundation for Cross-Connection Control and Hydraulic Research at the University of Southern California lab tests.

*Typical maximum flow rate (7.5 feet/sec.)

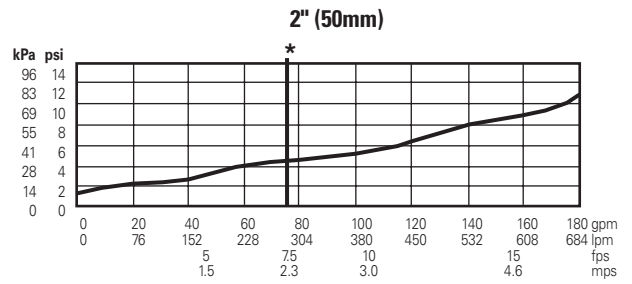
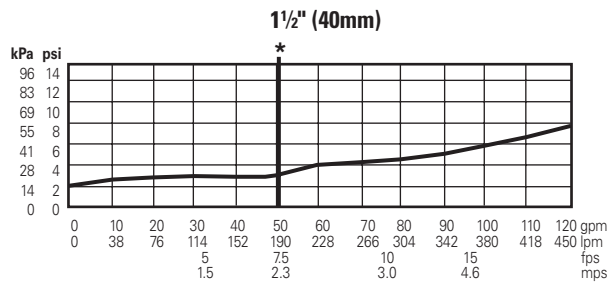
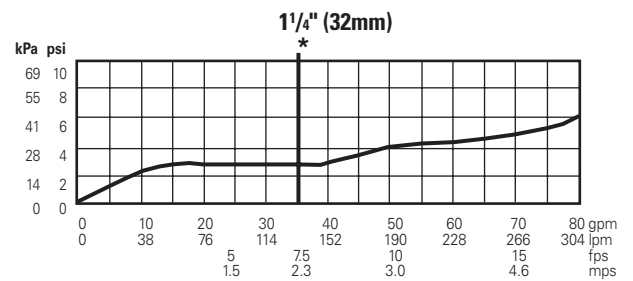
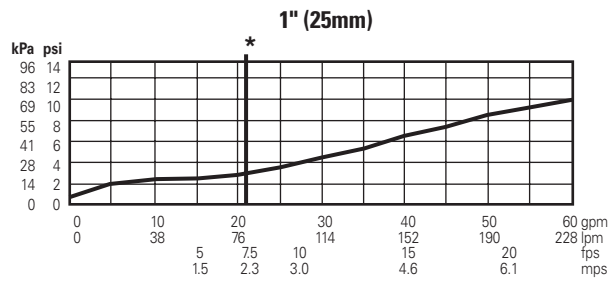
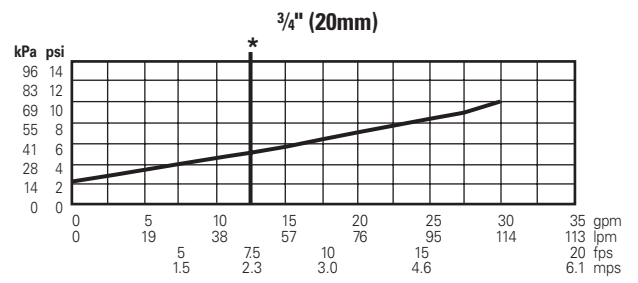
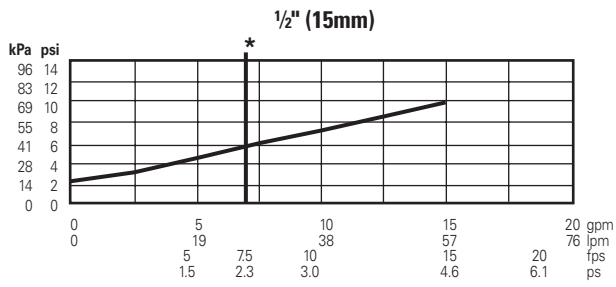

For additional information, visit our web site at: www.FEBCOonline.com



A Watts Water Technologies Company



USA: 4381 N. Brawley • Ste. 102 • Fresno, CA • 93722 • Tel. (559) 441-5300 • Fax: (559) 441-5301 • www.FEBCOonline.com
Canada: 5435 North Service Rd. • Burlington, ONT. • L7L 5H7 • Tel. (905) 332-4090 • Fax: (905) 332-7068 • www.FEBCOonline.ca

ES-F-767FR 0651

© 2009 FEBCO